

### Statement:

This manual is the intellectual property of Foxconn, Inc. Although the information in this manual may be changed or modified at any time, Foxconn does not obligate itself to inform the user of these changes.

### Trademark:



All trademarks are the property of their respective owners.

### Version:

User's Manual V1.0 in English for 661FX7MF/648FX7MF/648C7MF series motherboard.

P/N: 91-181-U48-M0-0E

### Symbol description:

-  **Note:** refers to important information that can help you to use motherboard better.
-  **Attention:** indicates that it may damage hardware or cause data loss, and tells you how to avoid such problems.
-  **Warning:** means that a potential risk of property damage or physical injury exists.

### More information:

If you want more information about our products, please visit Foxconn's website: <http://www.foxconnchannel.com>

### Item Checklist:

Thank for your purchasing Foxconn's 661FX7MF/648FX7MF/648C7MF series motherboard. Please check the package; if there are missing or damaged items, contact your distributor as soon as possible.

- ❖ 661FX7MF/648FX7MF/648C7MF series motherboard (x1)
- ❖ Foxconn Utility CD (x1)
- ❖ User's Manual (x1)
- ❖ RAID Manual (x1) (optional)
- ❖ IDE Ribbon Cable (x1)
- ❖ FDD Ribbon Cable (x1)
- ❖ I/O Shield (x1)
- ❖ S-ATA Signal Cable (x1) (optional)
- ❖ S-ATA Power Cable (x1) (optional)

# Declaration of conformity



**HON HAI PRECISION INDUSTRY COMPANY LTD**  
**66 , CHUNG SHAN RD., TU-CHENG INDUSTRIAL DISTRICT,**  
**TAIPEI HSIEN, TAIWAN, R.O.C.**

declares that the product

**Motherboard**

**661FX7MF/648FX7MF/648C7MF series**

is in conformity with

(reference to the specification under which conformity is declared in  
accordance with 89/336 EEC-EMC Directive)

- EN 55022/A1: 2000 Limits and methods of measurements of radio disturbance characteristics of information technology equipment
- EN 61000-3-2/A14:2000 Electromagnetic compatibility (EMC)  
Part 3: Limits  
Section 2: Limits for harmonic current emissions  
(equipment input current  $\leq$  16A per phase)
- EN 61000-3-3/A1:2001 Electromagnetic compatibility (EMC)  
Part 3: Limits  
Section 2: Limits of voltage fluctuations and flicker in low-voltage supply systems for equipment with rated current  $\leq$  16A
- EN 55024/A1:2001 Information technology equipment-Immunity characteristics limits and methods of measurement

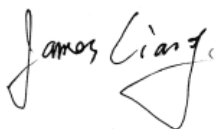
Signature : 

Place / Date : TAIPEI/2004

Printed Name : James Liang

Position/ Title : Assistant President

# Declaration of conformity



Trade Name: Foxconn  
Model Name: **661FX7MF/648FX7MF/648C7MF**  
Responsible Party: PCE Industry Inc.  
Address: 458 E. Lambert Rd.  
Fullerton, CA 92835  
Telephone: 714-738-8868  
Facsimile: 714-738-8838

Equipment Classification: FCC Class B Subassembly  
Type of Product: Motherboard  
**Manufacturer: HON HAI PRECISION INDUSTRY  
COMPANY LTD**  
Address: 66 , CHUNG SHAN RD., TU-CHENG  
INDUSTRIAL DISTRICT, TAIPEI HSIEN,  
TAIWAN, R.O.C.

## Supplementary Information:

This device complies with Part 15 of the FCC Rules. Operation is subject to the following two conditions : (1) this device may not cause harmful interference, and (2) this device must accept any interference received, including interference that may cause undesired operation.

Tested to comply with FCC standards.

Signature :

A handwritten signature in black ink that reads "James Liang". The signature is written in a cursive style with a large, stylized 'L' at the end.

Date : 2004

# Table of Contents

<b>Chapter 1</b>	<b>Product Introduction</b>	
Main Features .....		2
Motherboard Layout .....		5
<b>Chapter 2</b>	<b>Installation Instructions</b>	
CPU .....		8
Memory .....		12
Power Supply .....		14
Rear Panel Connectors .....		15
Other Connectors .....		17
Expansion Slots .....		21
Jumpers .....		23
<b>Chapter 3</b>	<b>BIOS Description</b>	
Enter BIOS Setup .....		26
Main Menu .....		26
Standard CMOS Features .....		28
BIOS Features .....		31
Advanced BIOS Features .....		32
Advanced Chipset Features .....		37
Integrated Peripherals .....		41
Power Management Setup .....		45
PnP/PCI Configurations .....		49
PC Health Status .....		50
Frequency/Voltage Control .....		51
Load Fail-Safe Defaults .....		52
Load Optimized Defaults .....		52
Set Supervisor/User Password .....		52
Save & Exit Setup .....		53
Exit Without Saving .....		53

# Table of Contents

**Chapter 4 Driver CD Introduction**

Utility CD content ..... 55  
Start to install drivers ..... 56

 **Warning:**

1. Attach the CPU and heatsink using silica gel to ensure full contact.
2. It is suggested to select high-quality, certified fans in order to avoid damage to the motherboard and CPU due to high temperatures.
3. Never turn on the machine if the CPU fan is not properly installed.
4. Ensure that the DC power supply is turned off before inserting or removing expansion cards or other peripherals, especially when you insert or remove a memory module. Failure to switch off the DC power supply may result in serious damage to your system or memory module.

 **Warning:**

We cannot guarantee that your system will operate normally while over-clocked. Normal operation depends on the over-clock capacity of your device.

 **Attention:**

Since BIOS programs are upgraded from time to time, the BIOS description in this manual is just for reference. We do not guarantee that the content of this manual will remain consistent with the actual BIOS version at any given time in the future.

 **Attention:**

The pictures of objects used in this manual are just for your reference. Please refer to the physical motherboard.

---

This manual is suitable for motherboard of 661FX7MF/648FX7MF/648C7MF series. Each motherboard is carefully designed for the PC user who wants diverse features.

- L supports onboard 100M LAN
- K supports onboard 1G LAN
- 6 supports 6-Channel Audio
- 8 supports 8-Channel Audio
- E supports 1394 function
- S supports SATA function
- R supports RAID function

You can find PPID label on the motherboard. It indicates the functions that the motherboard has.

*For example:*



*On the blue mark of the PPID label, it means the motherboard supports 6-Channel Audio (-6), 1394 function (-E), onboard 100M LAN (-L), SATA function (-S).*

---



# Chapter 1

Thank you for your buying Foxconn's 661FX7MF/648FX7MF/648C7MF series motherboard. This series of motherboard is one of our new products and offers superior performance, reliability and quality, at a reasonable price. This motherboard adopts the advanced SiS 661FX/648FX/648 + 964/964L chipset, providing users a computer platform with a high integration-compatibility-performance price ratio.

This chapter includes the following information:

- ❖ Main Features
- ❖ Motherboard Layout

### Main Features

#### Size

- mATX form factor of 9.6" x 8.3"

#### Microprocessor

- Supports Intel® Prescott-T processor in an LGA775 package
- Supports FSB at 533MHz/800MHz
- Supports Hyper-Threading technology

*Note: 648C7MF series motherboard do not support FSB 800MHz CPU.*

#### Chipset

- 661FX7MF Series: SiS 661FX (North Bridge) + SiS 964 (South Bridge)
- 648FX7MF Series: SiS 648FX (North Bridge) + SiS 964 (South Bridge)
- 648C7MF Series: SiS 648 (North Bridge) + SiS 964L (South Bridge)

#### System Memory

- Two 184-pin DIMM slots
- Supports PC 3200/PC 2700/PC 2100 memory
- Supports 128 Mb/256 Mb/512 Mb/1 Gb technology up to 2GB

*Note: 648C7MF series motherboard do not support PC3200 memory.*

#### USB 2.0 Ports

- Supports hot plug
- Eight USB 2.0 ports (four rear panel ports, two onboard USB header providing four extra ports)
- Supports wake-up from S1 and S3 mode
- Supports USB 2.0 protocol up to 480 Mbps transmission rate

#### Onboard Serial ATA (optional)



- 150MBps transfer rate
- Supports two S-ATA devices, such as HDD, etc.
- Supports RAID 0, RAID 1 and JBOD (optional)

### Onboard 1394 (-E optional) IEEE 1394

- Supports hot plug
- With rate of transmission up to 400Mbps
- Self-configured addressing
- Can connect with 2 independent 1394 units synchronously at most, such as HDD, CD-ROM

### Onboard LAN (-L)

- Supports 10/100Mbit/sec Ethernet
- LAN interface built-in on board

### AGP 8X AGP 8X

- AGP 8X (AGP 3.0) is the VGA interface specification that enabled enhanced graphics performance with high bandwidth speeds up to 2.12 GB/s

### Onboard Audio (-6)

- AC' 97 2.3 Specification Compliant
- Supports S/PDIF output
- Onboard Line-in jack, Microphone jack, Line-out jack
- Supports 5.1 channels audio (setting via software)

### Expansion Slots

- Three PCI slots
- One AGP slot

### BIOS

- Licensed advanced AWARD (Phoenix) BIOS, supports flash ROM, plug-and-play ready
- Supports HDD, CD-ROM or USB device boot up

### Green Function

- Supports ACPI (Advanced Configuration and Power Interface)
- Supports S0 (normal), S1 (power on suspend), S3 (suspend to RAM), S4 (suspend to disk – depends on OS) and S5 (soft-off)

### Advanced Features

- PCI 2.2 Specification Compliant
- Supports Windows 98/2000/ME/XP soft-off
- Supports Wake-on-LAN
- Supports PC Health function (capable of monitoring system voltage, CPU temperature, system temperature and fan speed)

Motherboard Layout

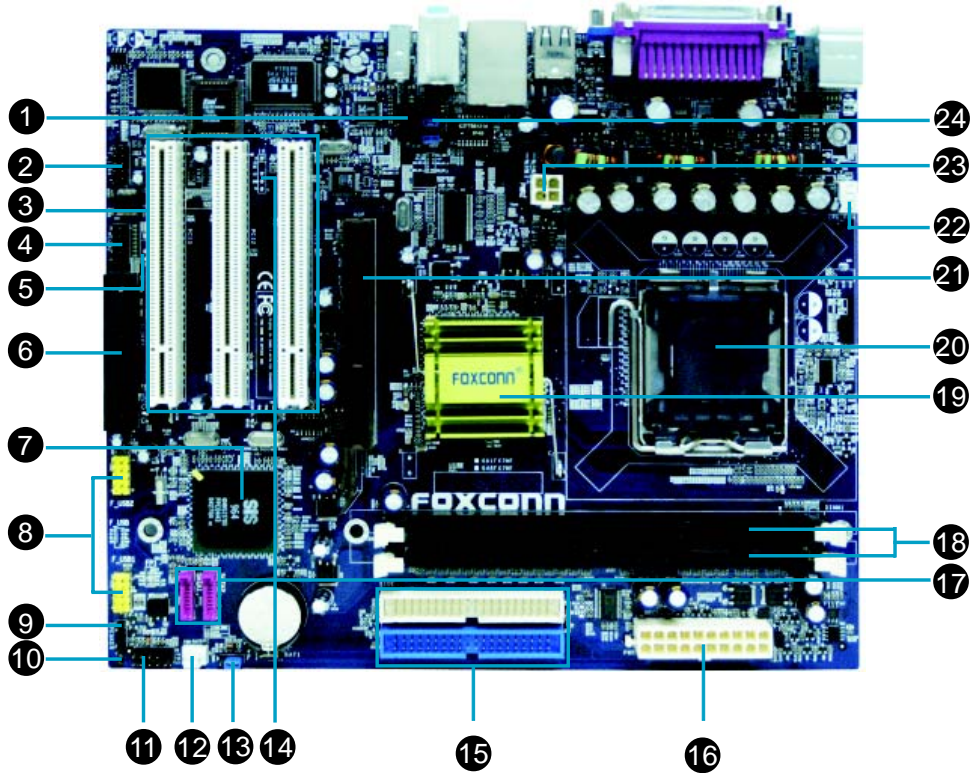

- |                                    |                                       |
|------------------------------------|---------------------------------------|
| 1. CD_IN Connector                 | 13. Clear CMOS Jumper                 |
| 2. 1394 Header (optional)          | 14. IrDA Header (optional)            |
| 3. PCI Slots                       | 15. HDD Connector                     |
| 4. COM2 Connector                  | 16. 20-pin ATX Power Connector        |
| 5. S/PDIF OUT Connector (optional) | 17. SATA Connector                    |
| 6. FDD Connector                   | 18. Memory Slots                      |
| 7. South Bridge: SiS 964/964L      | 19. North Bridge: SiS 661FX/648FX/648 |
| 8. Front USB Headers               | 20. CPU Socket                        |
| 9. Speaker Connector               | 21. AGP 8X Slot                       |
| 10. Chassis Intruder Connector     | 22. CPU Fan Connector                 |
| 11. Front Panel Connector          | 23. 4-pin ATX 12V Power Connector     |
| 12. System Fan Connector           | 24. Front Audio Connector             |

 Note:

The above motherboard layout is provided for reference only; please refer to the physical motherboard.

# Chapter 2

This chapter introduces the hardware installation process, including the installation of the CPU and memory. It also addresses the connection of your power supply, use of the rear panel connectors, connection of hard drive and floppy drive data cables, and setting up various other feature of the motherboard. Caution should be exercised during the installation process. Please refer to the motherboard layout prior to any installation and read the contents in this chapter carefully.

This chapter includes the following information:

- ❖ CPU
- ❖ Memory
- ❖ Power Supply
- ❖ Rear Panel Connectors
- ❖ Other Connectors
- ❖ Expansion Slots
- ❖ Jumpers

### Notes:

Take note of the following precautions before you install components or change settings.

1. Use a grounded wrist strap or touch a safely grounded object, such as an attached power supply, before handling components to avoid damaging them due to static electricity.
2. Unplug the power cord before opening your chassis or touching any component.
3. Hold components by their edges to avoid touching any exposed integrated circuits (ICs).
4. Whenever you uninstall a component, place it on a grounded anti-static pad or into anti-static bag that it came in.

### CPU

This motherboard supports single Pentium® 4 Processor including Prescott desktop CPUs in an LGA 775 package. It also supports Hyper-Threading Technology and FSB Dynamic Bus Inversion (DBI).

#### Installation of CPU

Below is the CPU socket illustration. Follow these procedures to install a CPU.

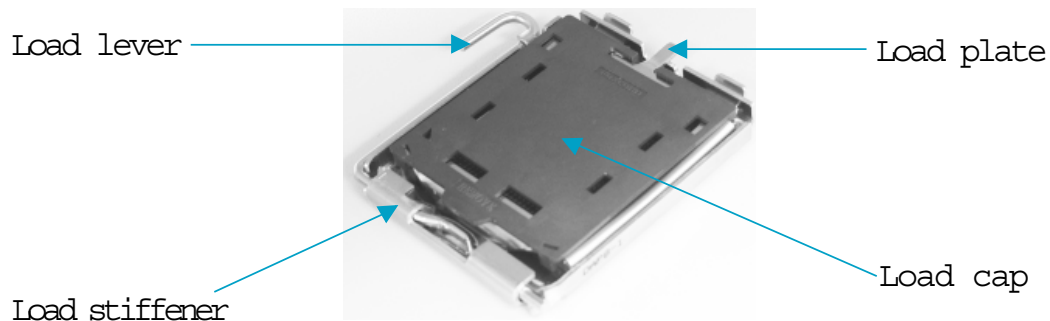

1. Use thumb & forefinger to hold the lifted tab of the cap.

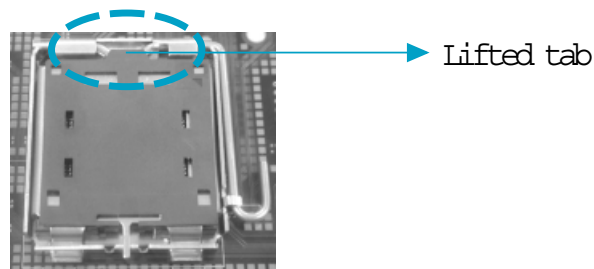

2. Lift the cap up and pick to upload the cap completely from the socket.

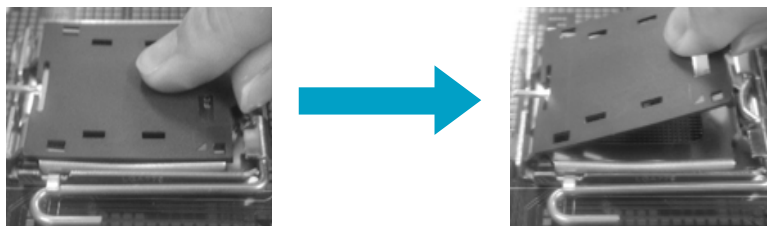



- Use thumb & forefinger to hold the hook of the load lever and pull the lever sideways to unlock it.

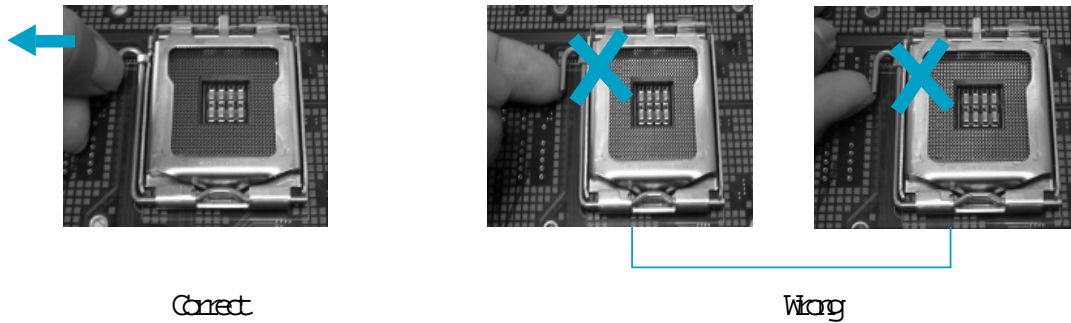

**Warning:**

DO NOT use finger to lift or tick the locking lever, the improper operation will cause finger hurt and the SKT in a poor operation condition.

- Lift up the lever. Use thumb to open the load plate. Be careful not to touch the contacts.

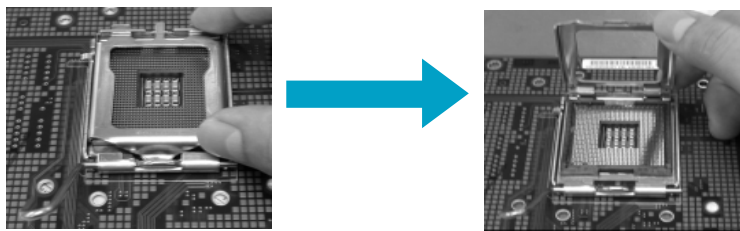

- Hold the CPU and tilt it to some degree since the contacts are designed to be hooked, then match the triangle marker to Pin 1 position as shown below. Carefully insert the CPU into the socket until it fits in place.

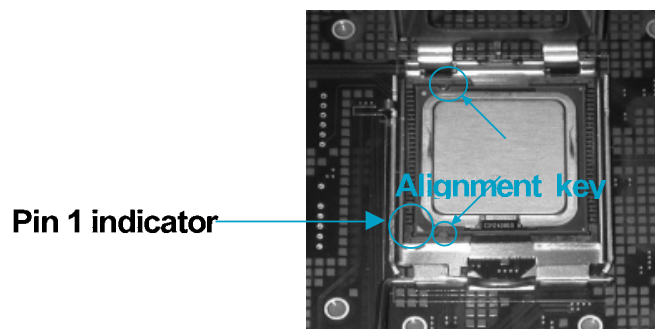

6. Close the load plate, and slightly push down the tongue side.

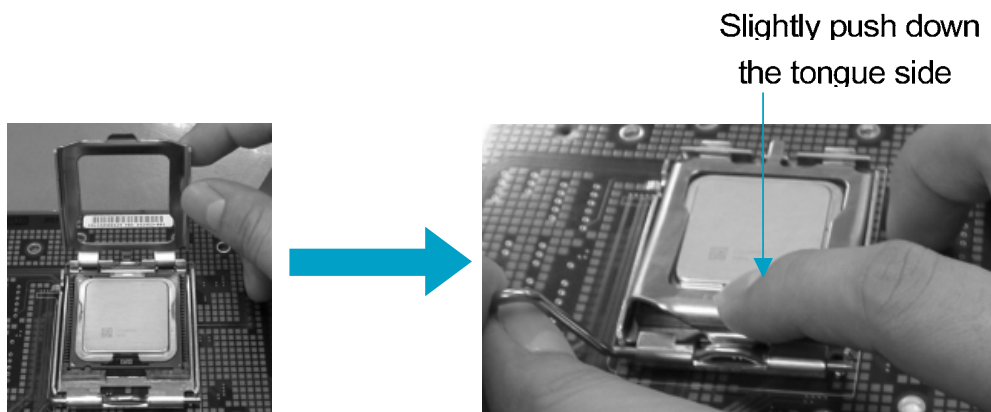

7. Lower the lever and lock it to the load plate, then the CPU is locked completely.



 Note :

Excessive temperatures will severely damage the CPU and system. Therefore, you should install CPU cooling fan and make sure that the cooling fan works normally at all times in order to prevent overheating and damaging to the CPU. Please refer to your CPU fan user guide to install it properly.

### CPU Qualified Vendor List

The following table lists the CPUs that have been tested and qualified for use with this motherboard.

661FX7MF & 648FX7MF Series:

Vendor	Type	F S B	Frequency
Intel	Pentium (prescott)	800MHz	3.0G
Intel	Pentium (prescott)	800MHz	3.2G
Intel	Pentium (prescott)	800MHz	3.6G
Intel	Celeron -D	533MHz	2.93G
Intel	Celeron -D	533MHz	3.06G
Intel	Pentium (prescott)	800MHz	3.4G

### Memory

This motherboard includes two, 184-pin, dual in-line memory module (DIMM) sockets. You can install corresponding PC 3200 (DDR400), PC 2700 (DDR333), or PC 2100 (DDR266) memory modules. You must install at least one memory module to ensure normal operation. If you install two modules, they must be the same speed. Mixed memory modules from different manufacturers is not recommended.

#### Installation of DDR Memory

1. There is only one gap in the center of the DIMM socket, and the memory module can be fixed in one direction only. Unlock a DIMM socket by pressing the module clips outward.
2. Align the memory module to the DIMM socket and insert the module vertically into the DIMM socket.

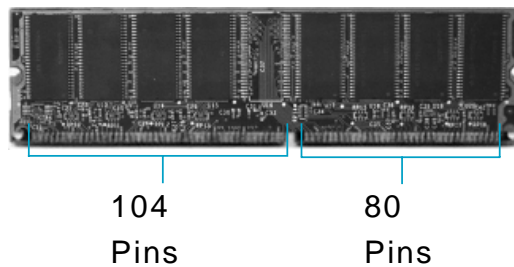

3. The plastic clips at both sides of the DIMM socket will lock automatically.

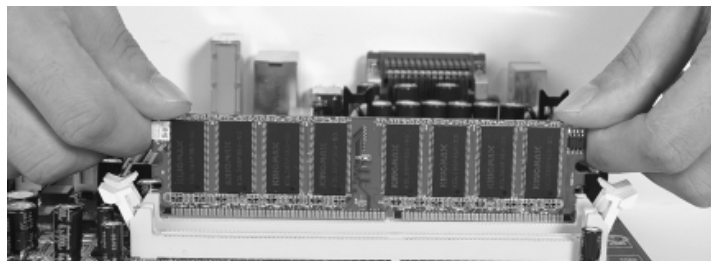

#### Warning :

Be sure to unplug the AC power supply before adding or removing expansion cards or other system peripherals, especially the memory devices, otherwise your motherboard or the system memory might be seriously damaged.

### Memory Qualified Vendor List

The following table lists the Memory modules that have been tested and qualified for use with this motherboard.

661FX7MF & 648FX7MF Series:

Vender	Type	Size
HLX	DDR400	256M
KINGMAX	DDR400/433	512M
LPT	DDR466	512M
SAMSUNG	DDR333	512M
SAMSUNG	DDR266	256M
BAMBO	DDR333	256M
KINGMAX	DDR333	256M
INFINEON	DDR266	256M
Apacer	DDR400	512M
Apacer	DDR333	256M
LPT	DDR466	256M, 512M
CORSAIR	DDR466	256M
CORSAIR	DDR500	256M
TWINMOS	DDR333	1G

 Note:

Make sure to use only the tested and qualified DDR DIMMs listed above. Other DDR DIMMs manufactured by other vendors may not be suitable for this motherboard.

### Power Supply

This motherboard uses an ATX power supply. In order to avoid damaging any devices, make sure that they have been installed properly prior to connecting the power supply.

20-pin ATX power connector: PWR1

PWR1 is the ATX power supply connector. Make sure that the power supply cable and pins are properly aligned with the connector on the motherboard. Firmly plug the power supply cable into the connector and make sure it is secure.

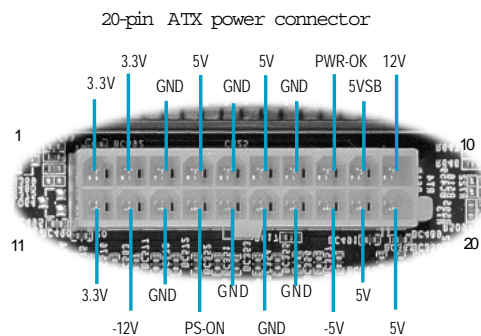

4-pin ATX\_12V Power Connector: PWR2

The ATX power supply connects to PWR2 and provides power to the CPU.

4-pin ATX\_12V power connector

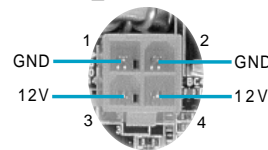

### **i** Attention:

You have to press the power button for more than four seconds if you change the default “Instant Off” setting to “Delay 4 Sec” from the “Power Button Override” option in the BIOS Power Management Setup.

### Rear Panel Connectors

This motherboard provides the ports as below:

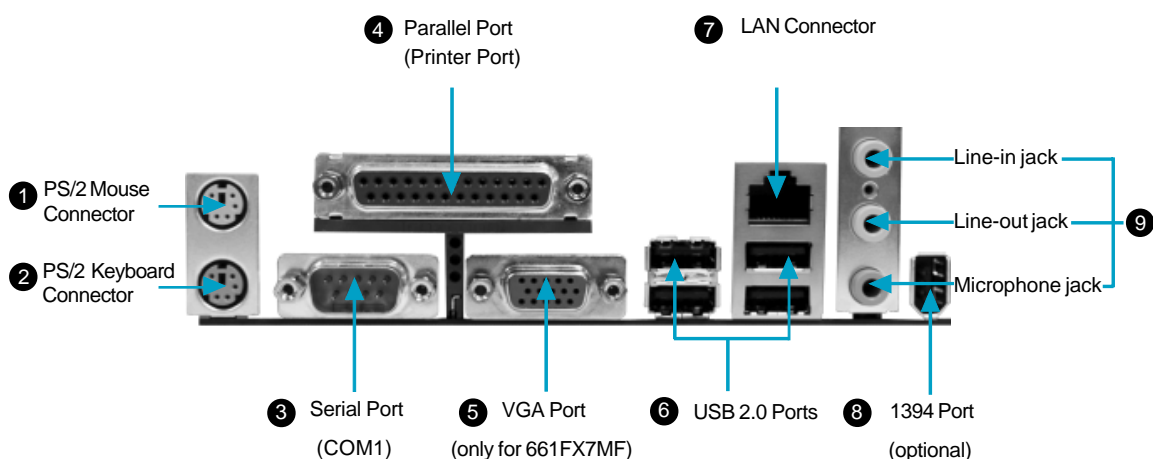

#### 1 PS/2 Mouse Connector

This green 6-pin connector is for a PS/2 mouse.

#### 2 PS/2 Keyboard Connector

This purple 6-pin connector is for a PS/2 keyboard.

#### 3 Serial Port (COM1)

This 9-pin COM1 port is for pointing devices or other serial devices.

#### 4 Parallel Port (Printer Port)

This 25-pin port connects a parallel printer, a scanner, or other devices.

#### 5 VGA Port (only for 661FX7MF)

The VGA Port is for output to a VGA-compatible device.

#### 6 USB 2.0 Ports

These four Universal Serial Bus (USB) ports are available for connecting USB 2.0/1.1 devices.

#### 7 LAN Connector

This port allows connection to a Local Area Network (LAN) through a network hub.

### 8 1394 Port (optional)

This digital interface supports electronic devices such as digital cameras, scanners and printers.

### 9 Line-in jack, Line-out jack, Microphone jack

When using a two-channel sound source, the Line-out jack is used to connect to speakers or headphones; the Line-in port connects to an external CD player, tape player or other audio device. The Microphone jack is used to connect to the microphone.

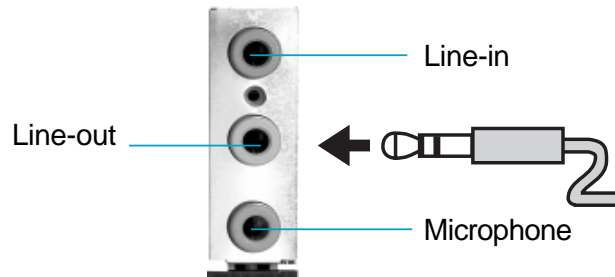

When using a 6-Channel sound source, connect the front speaker to the green audio output; connect the surround sound speaker to the blue audio input; connect the center speaker/subwoofer to the red Microphone input, as shown in the following figure:

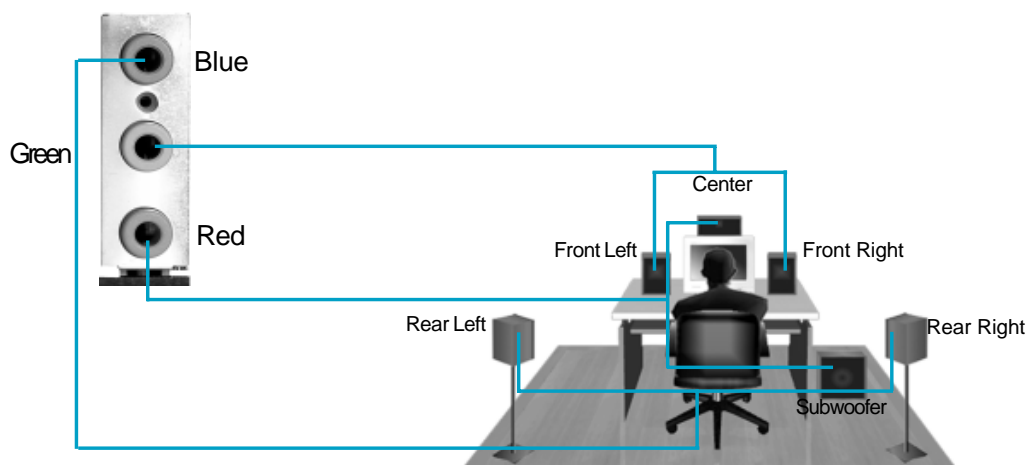



### Other Connectors

This motherboard includes connectors for FDD, IDE HDD, USB, CPU fan, system fan and others.

#### FDD Connector

This motherboard includes a standard FDD connector, supporting 360K, 720K, 1.2M, 1.44M, and 2.88M FDDs.

#### HDD connectors: PIDE & SIDE

This connectors supports the provided Ultra DMA 133/100/66 IDE hard disk ribbon cable. Connect the cable's blue connector to the primary (recommended) or secondary IDE connector, then connect the gray connector to the Ultra DMA 133/100/66 slave device (hard disk drive) and the black connector to the Ultra DMA 133/100/66 master device. If you install two hard disks, you must configure the second drive as a slave device by setting its jumper accordingly. Refer to the hard disk documentation for the jumper settings.

#### Attention:

Ribbon cables are directional, therefore, make sure to always connect with the cable on the same side as pin 1 of the PIDE/SIDE or FDD connector on the motherboard.

Front Panel Connector: F\_P1

This motherboard includes one connector for connecting the front panel switch and LED indicators.

Hard Disk LED Connector (IDE\_LED)

The connector connects to the case's IDE indicator LED indicating the activity status of IDE hard disk.

Reset Switch (RESET)

Attach the connector to the Reset switch on the front panel of the case; the system will restart when the switch is pressed.

Power LED Connector (PLED)

Attach the connector to the power LED on the front panel of the case. The Power LED indicates the system's status. When the system is in S0 status, the LED is on. When the system is in S1 status, the LED is blink; When the system is in S3, S4, S5 status, the LED is off.

Power Switch Connector (PWRBTN#)

Attach the connector to the power button of the case. Pushing this switch allows the system to be turned on and off rather than using the power supply button.

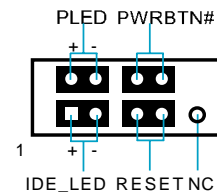

FP1

COM2 Connector: COM2

This connector accommodates a second serial port using an optional serial port bracket. Connect the bracket cable to this connector then install the bracket into a slot opening at the back of the system chassis.

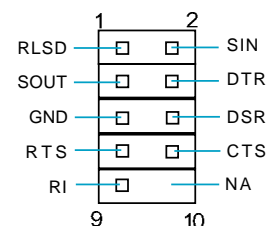

COM2

**IrDA Header:** IR (optional)

This connector supports wireless transmitting and receiving device. Before using this function, configure the settings of IR Address, IR Mode and IR IRQ from the “Integrated Peripherals” section of the CMOS Setup.

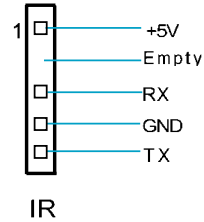

**USB Headers:** F\_USB1, F\_USB2

Besides four USB ports on the rear panel, the series of motherboards also have two 10-pin header on board which may connect to front panel USB cable (optional) to provide additional four USB ports.

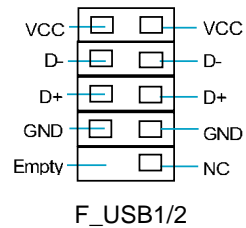

**Fan Connectors:** CPU\_FAN, FAN1

The speed of CPU\_FAN and FAN1 can be detected and viewed in “PC Health Status” section of the CMOS Setup. These fans will be automatically turned off after the system enters suspend mode.

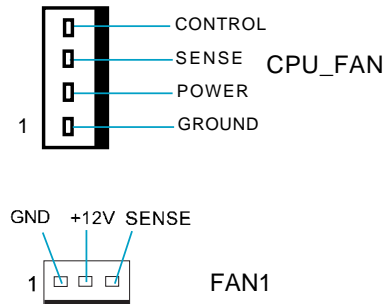

**Audio Connectors:** CD\_IN

CD\_IN is Sony standard CD audio connector, it can be connected to a CD-ROM drive through a CD audio cable.

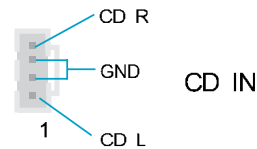

**1394 Header:** F\_1394 (optional)

The 1394 expansion cable can be connected to either the front (provided that the front panel of your chassis is equipped with the appropriate interface) or rear panel of the chassis.

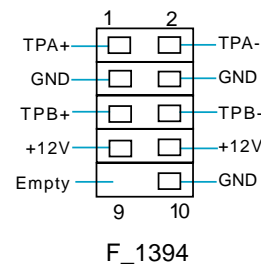

### Audio Interface: F\_AUDIO

The audio interface provides two kinds of audio output choices: the Front Audio, the Rear Audio. Their priority is sequenced from high to low (Front Audio to Rear Audio). If headphones are plugged into the front panel of the chassis (using the Front Audio), then the Line-out (Rear Audio) on the rear panel will not work. If you do not want to use the Front Audio, pin 5 and 6, pin9 and 10 must be short, and then the signal will be sent to the rear audio port.

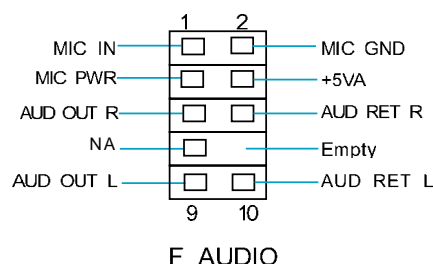

### S/PDIF Out Connector: SPD\_OUT (optional)

The S/PDIF out connector is capable of providing digital audio to external speakers or compressed AC3 data to an external Dolby digital decoder.

Note: The empty pin of S/PDIF cable should be aligned to empty pin of S/PDIF out connector.

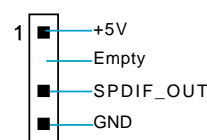

SPD\_OUT

### Chassis Intruder Connector: INTR

The connector connects to the chassis security switch on the case. The system can detect the chassis intrusion through the status of this connector. If the connector has been closed once, the system will send a message. To utilize this function, set “Case Open Warning” to “Enabled” in the “PC Health Status” section of the CMOS Setup. Save and exit, then boot the operating system once to make sure this function takes effect.

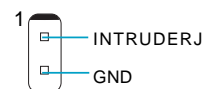

INTR

### Speaker Connector: SPEAKER

The speaker connector is used to connect speaker of the chassis.

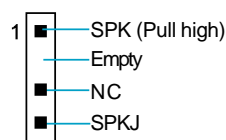

SPEAKER

### Expansion Slots

This motherboard includes three 32-bit master PCI bus slots, one AGP slot.

#### PCI Slots

The expansion cards can be installed in the three PCI slots. When you install or take out such cards, you must make sure that the power plug has been pulled out. Please read carefully the instructions provided for such cards, and install and set the necessary hardware and software for such cards, such as the jumper or BIOS setup.

#### AGP Slot

This motherboard has an AGP slot that supports 1.5V AGP cards. AGP is an interfacing specification designed to display 3D images. It provides a specialized 66MHz, 32-bit channel to allow the graphic controller to directly access the master memory and supports 4X and 8X speeds.

#### Warning:

The motherboard may be damaged if a 3.3V AGP card is used. Make sure that your AGP card is 1.5V specification. Note the notches on the card golden fingers to ensure that they fit the AGP slot on your motherboard.

#### Installing an expansion card

1. Before installing the expansion card, read carefully the documentation that came with it and make the necessary hardware settings for the card.
2. Make sure to unplug the power cord before adding or removing any expansion cards.
3. Remove the bracket opposite the slot that you intend to use.
4. Align the card connector with the slot and press firmly until the card is completely seated in the slot.
5. Secure the card to the chassis with the screw you removed earlier.

### AGP Qualified Vendor List

The following table lists the AGP cards that have been tested and qualified for use with this motherboard.

#### 661FX7MF & 648FX7MF Series:

Vender	Type	Video Memory
FX 5200	GEFORCE FX5200	128M DDR
ATI	ATI9200	128M DDR
MSI8923	GeForce FX5200	128M DDR
ASUS V9180	GF4FX 440-8X	64M DDR
ATI	ATI9500	128M DDR
MSI5800	GeForce FX5800	128M DDR
TYAN9700	ATI9700	128M DDR
ELIXIR FX5200	GeForce FX5200	128M DDR
ATI	ATI9000	64M DDR

 Note:

Make sure to use only the tested and qualified AGP cards listed above. Other AGP cards manufactured by other vendors may not be suitable for this motherboard.

### Jumpers

The users can change the jumper settings on this motherboard if needed. This section explains how to use the various functions of this motherboard by changing the jumper settings. Users should read the following contents carefully prior to modifying any jumper settings.

#### Description of Jumpers

1. For the jumpers on this motherboard, pin 1 can be identified by the silk-screen printed “△” next to it. However, in this manual, pin 1 is simply labeled as “1”.
2. The following table provides some explanation of the jumper pin settings. User should refer to this when adjusting jumper settings.

Jumper	Diagram	Definition	Description
1 (□ □ □)	1 (■ ■ □)	1-2	Set pin1 and pin2 closed
	1 (□ ■ ■)	2-3	Set pin2 and pin3 closed
1 (□ □)	1 (■ ■)	Closed	Set the pin closed
	1 (□ □)	Open	Set the pin opened

#### Clear CMOS Jumper: CLS\_CMOS

This motherboard uses the CMOS RAM to store all the set parameters. The CMOS can be cleared by removing the CMOS jumper.

#### How to clear CMOS?

1. Turn off the AC power supply and quickly connect pins 1 and 2 together using the jumper cap.
2. Return the jumper setting to normal (pins 2 and 3 locked together with the jumper cap).
3. Turn the AC power supply back on.

Normal Status  
(Default)   
1 2 3

Clear CMOS   
1 2 3

Clear CMOS Jumper

#### Warning:

1. Disconnect the power cable before adjusting the jumper settings.
2. Do not clear the CMOS while the system is turned on.

### Starting up for the first time

1. After making all the connections, replace the system case cover.
2. Be sure that all switches are off.
3. Turn on the devices in the following order.
  - a. Monitor
  - b. External SCSI devices (starting with the last device on the chain)
  - c. System power
4. After applying power Led on the system front panel case lights up. For ATX power supplies, the system LED lights up when you press the ATX power switch. If your monitor complies with green standards or if it has a power standby feature, the monitor LED may light up or switch between orange and green after the system LED turns on. The system then runs the power-on tests. While the tests are running, the BIOS beeps or additional messages appear on the screen. If you do not see anything within 30 seconds from the time you turned on the power, the system may have failed a power-on test. Check the jumper settings and connections or call your retailer for assistance.
5. At power on, hold down <Delete> to enter BIOS Setup. Follow the instructions in Chapter 3.

### Powering off the computer

1. Using the OS shut down function  
If you use windows 98/ME/2000/XP, click the Start button, click Shut Down, then click the OK button to shut down the computer. The power supply should turn off after Windows shuts down.
2. Using the dual function power switch  
While the system is ON, pressing the power switch for less than 4 seconds puts the system to sleep mode or to soft-off mode, depending on the BIOS setting. Pressing the power switch for more than 4 seconds lets the system enter the soft-off mode regardless of the BIOS setting.



# Chapter 3

This chapter tells how to change system settings through the BIOS Setup menus. Detailed descriptions of the BIOS parameters are also provided.

You have to run the Setup Program when the following cases occur:

1. An error message appears on the screen during the system POST process.
2. You want to change the default CMOS settings.

This chapter includes the following information:

- ❖ Enter BIOS Setup
- ❖ Main Menu
- ❖ Standard CMOS Features
- ❖ BIOS Features
- ❖ Advanced BIOS Features
- ❖ Advanced Chipset Features
- ❖ Integrated Peripherals
- ❖ Power Management Setup
- ❖ PnP/PCI Configurations
- ❖ PC Health Status
- ❖ Frequency/Voltage Control
- ❖ Load Fail-Safe Defaults
- ❖ Load Optimized Defaults
- ❖ Set Supervisor/User Password
- ❖ Save & Exit Setup
- ❖ Exit Without Saving

### Enter BIOS Setup

The BIOS is the communication bridge between hardware and software, correctly setting up the BIOS parameters is critical to maintain optimal system performance. Power on the computer, when the following message briefly appears at the bottom of the screen during the POST (Power On Self Test), press <Del> key to enter the AWARD BIOS CMOS Setup Utility.

Press TAB to show POST screen, DEL to enter SETUP.

 Note:

We do not suggest that you change the default parameters in the BIOS Setup, and we shall not be responsible for any damage that result from any changes that you make.

### Main Menu

The main menu allows you to select from the list of setup functions and two exit choices. Use the arrow keys to select among the items and press <Enter> to accept or go to the sub-menu.

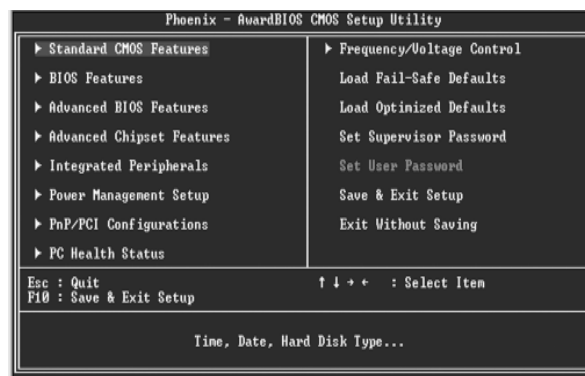

Main Menu

The items in the main menu are explained as below:

Standard CMOS Features

The basic system configuration can be set up through this menu.

BIOS Features

The special features can be set up through this menu.

### Advanced BIOS Features

The advanced system features can be set up through this menu.

### Advanced Chipset Features

The values for the chipset can be changed through this menu, and the system performance can be optimized.

### Integrated Peripherals

All onboard peripherals can be set up through this menu.

### Power Management Setup

All the items of green function features can be set up through this menu.

### PnP/PCI Configurations

The system's PnP/PCI settings and parameters can be modified through this menu.

### PC Health Status

This will display the current status of your PC.

### Frequency/Voltage Control

Frequency and voltage settings can be adjusted through this menu.

### Load Fail-Safe Defaults

The default BIOS settings can be loaded through this menu.

### Load Optimized Defaults

The optimal performance settings can be loaded through this menu, however, the stable default values may be affected.

### Set Supervisor/User Password

The supervisor/user password can be set up through this menu.

### Save & Exit Setup

Save CMOS value settings to CMOS and exit setup.

### Exit Without Saving

Abandon all CMOS value changes and exit setup.

Standard CMOS Features

This sub-menu is used to set up the standard CMOS features, such as the date, time, HDD model and so on. Use the arrow keys select the item to set up, and then use the <PgUp> or <PgDn> keys to choose the setting values.



Standard CMOS Features Menu

Date

This option allows you to set the desired date (usually as the current date) with the <day><month><date><year> format.

Day—weekday from Sun. to Sat., defined by BIOS (read-only).

Month—month from Jan. to Dec..

Date—date from 1<sup>st</sup> to 31<sup>st</sup>, can be changed using the keyboard.

Year—year, set up by users.

Time

This option allows you to set up the desired time (usually as the current time) with <hour><minute><second> format.

IDE Channel 0/1 Master/Slave & IDE Channel 2/3 Master

These categories identify the HDD types of 2 IDE channels installed in the computer system. There are three choices provided for the Enhanced IDE BIOS: None, Auto, and Manual. “None” means no HDD is installed or set; “Auto” means the system can auto-detect the hard disk when booting up; by choosing “Manual” and changing Access Mode to “CHS”, the related information should be entered manually. Enter the information directly from the keyboard and press < Enter>:

Cylinder	number of cylinders	Head	number of heads
Precomp	write pre-compensation	Landing Zone	landing zone
Sector	number of sectors		

Award (Phoenix) BIOS can support 3 HDD modes: CHS, LBA and Large or Auto mode.

CHS	For HDD<528MB
LBA	For HDD>528MB & supporting LBA (Logical Block Addressing)
Large	For HDD>528MB but not supporting LBA
Auto	Recommended mode

### Drive A/B

This option allows you to select the kind of FDD to be installed, including “None”, [360K, 5.25 in], [1.2M, 5.25 in], [720K, 3.5 in], [1.44M, 3.5 in] and [2.88 M, 3.5 in].

### Video

The following table is provided for your reference in setting the display mode for your system.

EGAVGA	Enhanced Graphics Adapter / Video Graphic Array. For EGA, VGA, SEGA, SVGA, or PGA monitor adapters.
CGA 40	Color Graphic Adapter, powering up in 40 column mode.
CGA 80	Color Graphic Adapter, powering up in 80 column mode.
MONO	Monochrome adapter, including high resolution monochrome adapters.

### Halt On

This category determines whether or not the computer will stop if an error is detected during powering up.

All Errors	Whenever the BIOS detects a nonfatal error, the system will stop and you will be prompted.
No Errors	The system boot will not stop for any errors that may be detected.
All, But Keyboard	The system boot will not stop for a keyboard error; but it will stop for all other errors.
All, But Diskette	The system boot will not stop for a diskette error; but it will stop for all other errors.
All, But Disk/Key	The system boot will not stop for a keyboard or disk error, but it will stop for all other errors.

### Memory

This is a Display-Only Category, determined by POST (Power On Self Test) of the BIOS.

Base Memory	The BIOS POST will determine the amount of base (or conventional) memory installed in the system.
Extended Memory	The BIOS determines how much extended memory is present during the POST.
Total Memory	Total memory of the system.

BIOS Features

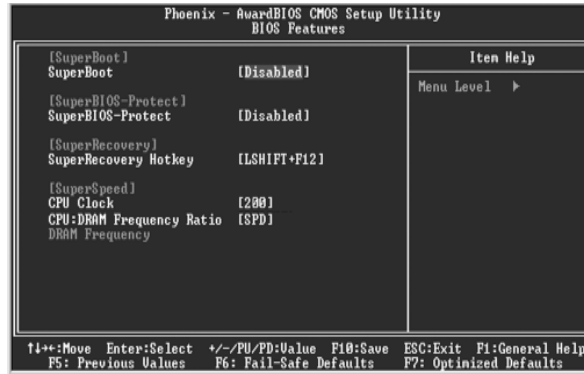

BIOS Features Menu

- ❖ [SuperBoot] SuperBoot (Default: Disabled)  
SuperBoot allows system-relevant information to be stored in CMOS upon the first normal start-up of your PC, and the relevant parameters will be restored to help the system start up more quickly on each subsequent start-up. The available setting values are: Disabled and Enabled.
- ❖ [SuperBIOS-Protect] SuperBIOS-Protect (Default: Disabled)  
SuperBIOS-Protect function protects your PC from being affected by viruses, e.g. CIH. The available setting values are: Disabled and Enabled.
- ❖ [SuperRecovery] SuperRecovery Hotkey (Default: LSHIFT+F12)  
SuperRecovery provides the users with an excellent data protection and HDD recovery function. There are 12 optional hotkey and the default hotkey is LSHIFT+F12.
- ❖ [SuperSpeed] CPU Clock (Depending on the specification of the CPU)  
The conventional over-clock method uses the jumpers on the motherboard, and it is both troublesome and apt to errors. By using SuperSpeed, a CPU can be overclocked by keying in the desired in the CPU clock range.
- ❖ CPU: DRAM Frequency Ratio (Default: SPD)  
This option is used to set CPU:DRAM Frequency Ratio.
- ❖ DRAM Frequency  
This option is used to show DRAM frequency.

 Warning:

Be sure your selection is right. CPU overclock will be dangerous!  
We will not be responsible for any damage caused.

### Advanced BIOS Features

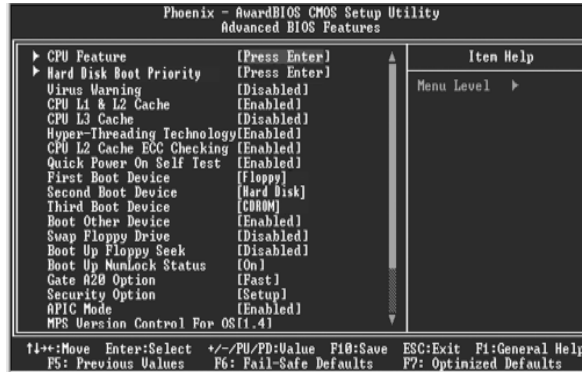

Advanced BIOS Features Menu

#### ❖ CPU Feature

Press enter to set the items of CPU feature. Please refer to page 36.

#### ❖ Hard Disk Boot Priority

This option is used to select the priority for HDD startup. After pressing <Enter>, you can select the HDD using the <PageUp>/<PageDn> or Up/Down arrow keys, and change the HDD priority using <+> or <->; you can exit this menu by pressing <Esc>.

#### ❖ Virus Warning (Default: Disabled)

Allows you to choose the VIRUS warning feature for IDE hard disk boot sector protection. If this function is enabled and someone attempt to write data into this area, BIOS will show a warning message on screen and an alarm will beep. The available setting values are: Disabled and Enabled.

Note: Such function provides protection to the start-up sector only; it does not protect the entire hard disk.

#### ❖ CPU L1 & L2 Cache (Default: Enabled)

This option is used to enable or disable the CPU L1 and L2 cache. The available setting values are: Disabled and Enabled.

#### ❖ CPU L3 Cache (Default: Disabled) (optional)

This option is used to enable or disable CPU L3 cache. The available setting values are: Disabled and Enabled.



- ❖ Hyper-Threading Technology (Default: Enabled) (optional)

This option is used to turn on or off the Hyper-Threading function of the CPU. The available setting values are: Disabled and Enabled.

Note: This function will not be displayed until a CPU that supports Hyper-Threading has been installed.
- ❖ CPU L2 Cache ECC Checking (Default: Enabled)

This option is used to enable or disable CPU L2 cache ECC Checking. The available setting values are: Disabled and Enabled.
- ❖ Quick Power On Self Test (Default: Enabled)

Enable this option to shorten the power on testing (POST) and have your system start up faster. The available setting values are: Disabled and Enabled.
- ❖ First/Second/Third Boot Device (Default: Floppy/Hard Disk/CDROM)

This option allows you to set the boot device's sequence. The available setting values are: Floppy, LS120, Hard Disk, CDROM, ZIP100, USB-FDD, USB-ZIP, USB-CDROM, LAN, and Disabled.
- ❖ Boot Other Device (Default: Enabled)

With this function set to enable, the system will to boot from some other devices if the first/second/third boot devices failed. The available setting values are: Disabled and Enabled.
- ❖ Swap Floppy Drive (Default: Disabled)

If you have two floppy diskette drives in your system, this option allows you to swap the assigned drive letters. The available setting values are: Disabled and Enabled.
- ❖ Boot Up Floppy Seek (Default: Disabled)

If this option is enabled, BIOS will activate the floppy drive during the system boot and the drive's indicator will flash after the activation. The magnetic head will move back and forth from A to B. The available setting values are: Disabled and Enabled.
- ❖ Boot Up NumLock Status (Default: On)

This option defines if the keyboard Num Lock key is active when your system is started. The available setting values are: On and Off.
- ❖ Gate A20 Option (Default: Fast)

This option is used to set up the A20 signal control necessary for access to the 1MB memory. The available setting values are: Normal and Fast.

- ❖ **Typematic Rate Setting (Default: Disabled)**

If this option is enabled, you can use the following two items to see the typematic rate and the typematic delay settings for your keyboard. The available setting values are: Disabled and Enabled.
- ❖ **Typematic Rate (Chars/Sec) (Default: 6)**

Use this option to define how many characters per second a held-down key generated.
- ❖ **Typematic Delay (Msec) (Default: 250)**

Use this option to define how many milliseconds must elapse before a held-down key begins generating repeat characters.
- ❖ **Security Option (Default: Setup)**

When it is set to “Setup”, a password is required to enter the CMOS Setup screen; When it is set to “System”, a password is required not only to enter CMOS Setup, but also to start up your PC.
- ❖ **APIC Mode (Default: Enabled)**

This option is used to enable or disable APIC mode.
- ❖ **MPS Version Control For OS (Default: 1.4)**

This option is used to set up the version of MPS Table used in NT4.0 OS.
- ❖ **OS Select For DRAM > 64MB (Default: Non-OS2)**

This option is only required if you have installed more than 64 MB of memory and you are running the OS/2 operating system. Otherwise, leave this option at the default.
- ❖ **HDD S.M.A.R.T Capability (Default: Disabled)**

This option is used to enable or disable hard disk S.M.A.R.T. support function. The available setting values are: Disabled and Enabled.
- ❖ **Report No FDD For WIN 95 (Default: No)**

If you are using the Windows 95 and running a system with on floppy drive, select “Yes” for this option to ensure compatibility with Windows 95 logo certification. The available setting values are: No and Yes.
- ❖ **Video BIOS Shadow (Default: Enabled)**

This option is used to enable or disable Video BIOS Shadow. If you enable this option, the video BIOS will be copied to RAM. Video shadow will increase the video speed. The available setting values are: Disabled and Enabled.

❖ Full Screen LOGO Show (Default: Enabled)

This option allows you to enable or disable the full screen logo. The available setting values are: Disabled and Enabled.

❖ Small Logo (EPA) Show (Default: Disabled)

This option allows you to enable or disable the EPA logo. The available setting values are: Disabled and Enabled.

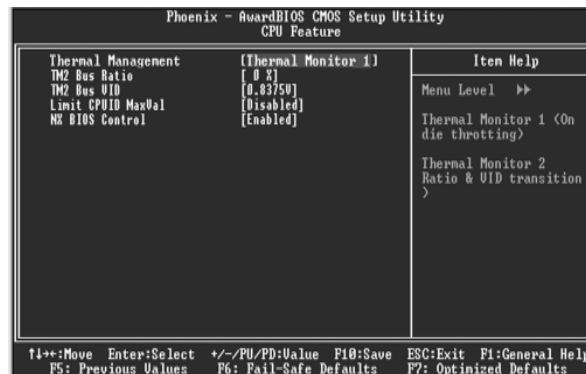

CPU Feature Menu

- ❖ Thermal Management (Default: Thermal Monitor 1)  
This option is used to manage Prescott CPU thermal.  
Note: This option will not be displayed until a Prescott CPU has been installed.
- ❖ TM2 Bus Ratio (Default: depend on CPU) (optional)  
Represents the frequency bus ratio of the throttled performance state that will be initiated when the on-die sensor goes from not hot to hot.
- ❖ TM2 Bus VID (Default: depend on CPU) (optional)  
Represents the voltage of the throttled performance state that will be initiated when the on-die sensor goes from not hot to hot.
- ❖ Limit CPUID MaxVal (Default: Disabled) (optional)  
The option is used to set limit CPUID MaxVal. The available setting values are: Disabled and Enabled.
- ❖ NX BIOS Control (Default: depend on CPU) (optional)  
When disabled, forces the NX feature flag to always return 0. The available setting values are: Disabled and Enabled.

### Advanced Chipset Features

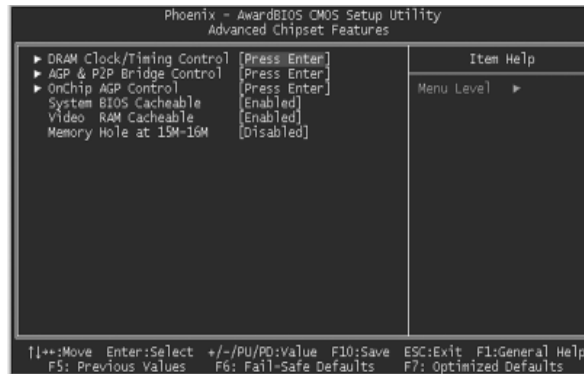

Advanced Chipset Features Menu

- ❖ DRAM Clock/Timing Control  
Press enter to set the items about DDR RAM. Please refer to page 38.
- ❖ AGP & P2P Bridge Control  
Press enter to set the items about AGP. Please refer to page 39.
- ❖ OnChip AGP Control (only for 661FX7MF)  
Press enter to set the items about onchip AGP. Please refer to page 40.
- ❖ System BIOS Cacheable (Default: Enabled)  
Select "Enabled" to allow caching of the system BIOS which may improve performance. If any other program writes to this memory area, a system error may result. The available setting values are: Enabled and Disabled.
- ❖ Video RAM Cacheable (Default: Enabled)  
Select "Enabled" to allow caching of the Video BIOS which may improve performance. If any other program writes to this memory area, a system error may result. The available setting values are: Enabled and Disabled.
- ❖ Memory Hole at 15M-16M (Default: Disabled)  
This option is used to determine whether the 15M-16M address field of memory is reserved for the ISA expansion card. The available setting values are: Enabled and Disabled.

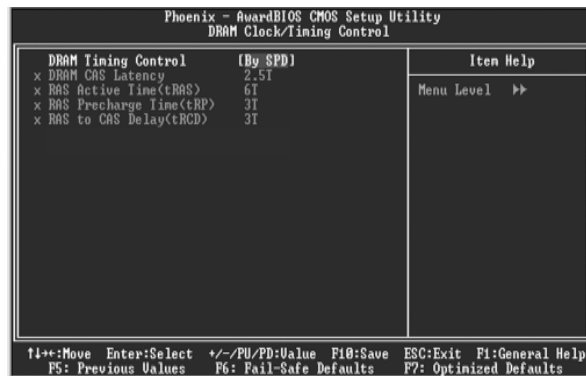

DRAM Clock/Timing Control Menu

- ❖ DRAM Timing control (Default: By SPD)  
This option determines DRAM timing using SPD or manual configuration. Only set as manual, the following 4 items can be updated.
- ❖ DRAM CAS Latency (Default: depend on memory)  
This option determines CAS Latency. The available setting values are: 2T, 2.5T, 3T.
- ❖ RAS Active Time (tRAS) (Default: depend on memory)  
This option determines RAS active time. The available setting values are: 4T - 9T.
- ❖ RAS Precharge Time (tRP) (Default: depend on memory)  
This option is used to define the idle clocks after issuing a precharge command to the SDRAM.
- ❖ RAS to CAS Delay (tRCD) (Default: depend on memory)  
This option is used to define the minimum RAS to CAS delay using 1us granularity.

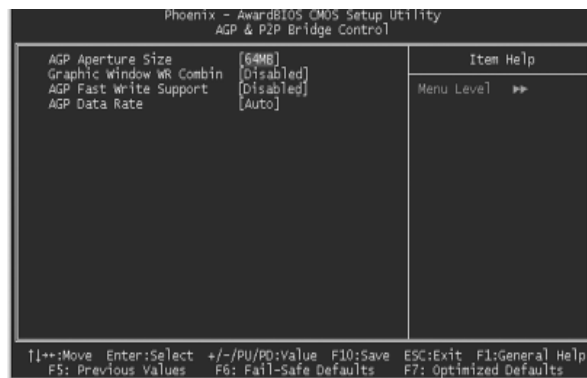

AGP & P2P Bridge Control Menu

- ❖ AGP Aperture Size (Default: 64 MB)  
This option defines the size of the aperture if you use an AGP graphics adapter. The aperture is a portion of the PCI memory address range dedicated for graphic memory address space.  
Note: This function does not work when Onboard VGA is used.
- ❖ Graphic Window WR Combin (Default: Disabled) (only for 661FX7MF)  
This option is used to disable or enable Graphic Window Write Combin mode.
- ❖ AGP Fast Write Support (Default: Disabled) (only for 661FX7MF)  
Use this option to enable or disable AGP fast write support.
- ❖ AGP Data Rate (Default: Auto) (only for 661FX7MF)  
Use this option to set AGP data rate.

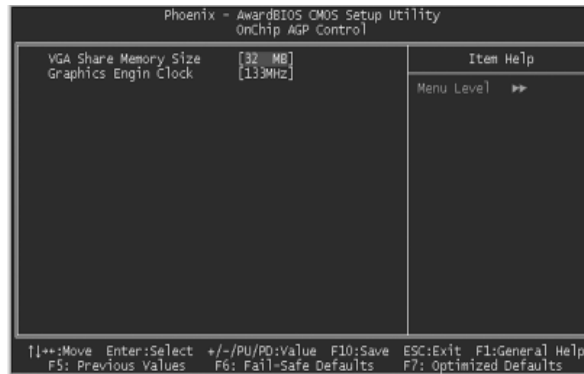

OnChip AGP Control Menu

- ❖ **VGA Share Memory Size** (Default: 32 MB) (only for 661FX7MF)  
This option is used to set the onboard VGA share memory size. The available settings are 16MB, 32MB, 64MB, 128MB.
- ❖ **Graphics Engin Clock** (Default: 133 MHz) (only for 661FX7MF)  
This option is used to set onchip AGP graphics engine clock. The available settings are 100 MHz, 133MHz, 166MHz, 200MHz.



## Integrated Peripherals

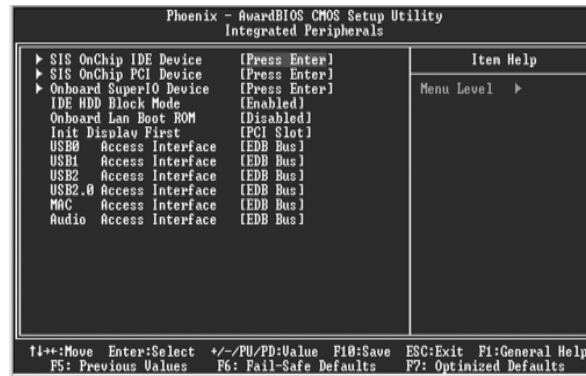

### Integrated Peripherals Menu

- ❖ SIS Onchip IDE Device  
Press enter to set onchip IDE device. Please refer to page 42.
- ❖ SIS Onchip PCI Device  
Press enter to set onchip PCI device. Please refer to page 43.
- ❖ Onboard SuperIO Device  
Press enter to set onboard superIO device. Please refer to page 44.
- ❖ IDE HDD Block Mode (Default: Enabled)  
This option is used to set whether the IDE HDD block mode is allowed. The available setting values are: Disabled and Enabled.
- ❖ Onboard Lan Boot ROM (Default: Disabled)  
This option is used to decide whether to invoke the boot ROM of the onboard LAN chip.
- ❖ Init Display First (Default: PCI Slot)  
This option is used to set which display device will be used first when your PC starts up. The available setting values are: AGP and PCI Slot.
- ❖ USB0/1/2/2.0 Access Interface (Default: EDB Bus)  
This option is used to set USB0/1/2/2.0 Access Interface. The available setting values are: PCI Bus and EDB Bus.
- ❖ MAC Access Interface (Default: EDB Bus)  
This option is used to set MAC access interface. The available setting values are: PCI Bus and EDB Bus.
- ❖ Audio Access Interface (Default: EDB Bus)  
This option is used to set audio Access Interface. The available setting values are: PCI Bus and EDB Bus.

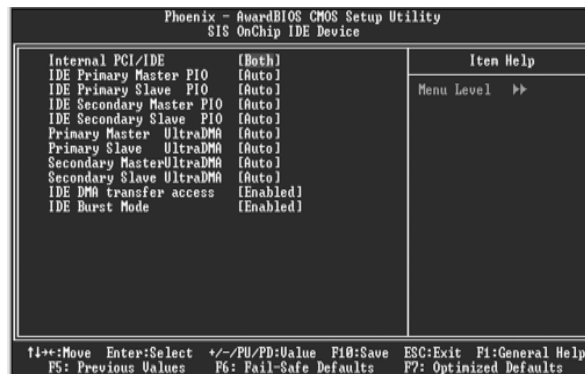

SIS OnChip IDE Device Menu

- ❖ Internal PCI/IDE (Default: Both)  
 This option is used to set the ports of onboard IDE. The available setting values are: Disabled, Primary, Secondary and Both.
- ❖ IDE Primary/ Secondary Master/Slave PIO (Default: Auto)  
 These four items let you assign which kind of PIO (Programmed Input/Output) is used by IDE devices. Choose Auto to let the system auto detect which PIO mode is the best or select a PIO mode from 0-4.
- ❖ Primary/Secondary Master/Slave UltraDMA (Default: Auto)  
 UltraDMA technology provides faster access to IDE devices. If you install a device that supports UltraDMA, change the appropriate item on this list to Auto. The available setting values are: Disabled and Auto.
- ❖ IDE DMA transfer access (Default: Enabled)  
 This option is used to enable or disable IDE DMA transfer access.
- ❖ IDE Burst Mode (Default: Enabled)  
 This option is used to enable or disable IDE burst mode.

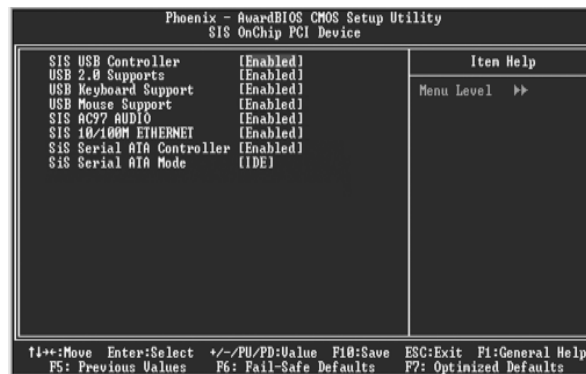

SIS OnChip PCI Device Menu

- ❖ SIS USB Controller (Default: Enabled)  
This option is used to enable or disable SIS USB controller.
- ❖ USB 2.0 Supports (Default: Enabled)  
This option is used to enable or disable USB 2.0.
- ❖ USB Keyboard Support (Default: Enabled)  
This option is used to enable or disable USB keyboard under legacy OS.
- ❖ USB Mouse Support (Default: Enabled)  
This option is used to enable or disable USB mouse under legacy OS.
- ❖ SIS AC97 AUDIO (Default: Enabled)  
This option is used to enable or disable SIS AC97 AUDIO.
- ❖ SIS 10/100M ETHERNET (Default: Enabled)  
This option is used to enable or disable SIS 10/100M ethernet.
- ❖ SiS Serial ATA Controller (Default: Enabled)  
This option is used to enable or disable SiS serial ATA controller. The available setting values are: Disabled and Enabled.
- ❖ SiS Serial ATA Mode (Default: IDE)  
This option is used to set Serial ATA mode. The default is recommended. The available setting values are: IDE and RAID.

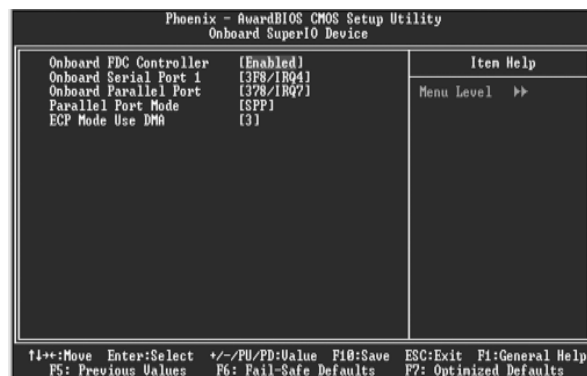

Onboard SuperIO Device Menu

- ❖ Onboard FDC Controller (Default: Enabled)  
This option is used to set whether the Onboard FDC Controller is enabled. The available setting values are: Disabled and Enabled.
- ❖ Onboard Serial Port1/2 (Default: 3F8/IRQ4 / 2F8/IRQ3)  
This option is used to assign the I/O address and interrupt request (IRQ) for the onboard serial port 1/2.  
**Note: Do not try to set the same values for serial ports 1 and 2.**
- ❖ Onboard Parallel Port (Default: 378/IRQ7)  
This option allows you to determine onboard parallel port controller I/O address and interrupt request (IRQ). Setting values include Disabled, 378/IRQ7, 278/IRQ5 and 3BC/IRQ7.
- ❖ Parallel Port Mode (Default: SPP)  
Select an address and corresponding interrupt for the onboard parallel port. Setting values include SPP, EPP, ECP, ECP+EPP.
- ❖ ECP Mode Use DMA (Default: 3)  
Select a DMA Channel for the parallel port when using the ECP mode. This field is only configurable if Parallel Port Mode is set to ECP. The available setting values are: 3 and 1.

Power Management Setup

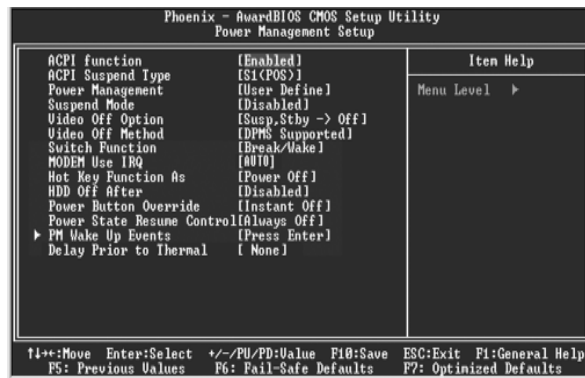

Power Management Setup Menu

- ❖ ACPI function (Default: Enabled)
 

ACPI stands for “Advanced Configuration and Power Interface”. ACPI is a standard that defines power and configuration management interfaces between an operating system and the BIOS. In other words, it is a standard that describes how computer components work together to manage system hardware. In order to use this function the ACPI specification must be supported by the OS (for example, Windows 2000 or Windows XP). The available setting values are: Enabled and Disabled.
- ❖ ACPI Suspend Type (Default: S1 (POS))
 

This option is used to set the energy saving mode of the ACPI function. When you select “S1 (POS)” mode, the power will not shut off and the supply status will remain as it is, in S1 mode the computer can be resumed at any time. When you select “S3 (STR)” mode, the power will be cut off after a delay period. The status of the computer before it enters STR will be saved in memory, and the computer can quickly return to previous status when the STR function wakes. When you select “S1 & S3” mode, the system will automatically select the delay time.
- ❖ Power Management (Default: User Define)
 

This option is used to set the power management scheme. Available settings are: User Define, Min Saving and Max Saving.
- ❖ Suspend Mode (Default: Disabled)
 

This option is used to set the idle time before the system enters into sleep status. The setting values are: Disabled and 1 Min - 1 hour.
- ❖ Video Off Option (Default: Susp, Stby -> Off)
 

This option is used to set video off option. The setting values are: Always On, Suspend -> Off, Susp,Stby -> Off, All Modes -> Off.

- ❖ **Video Off Method (Default: DPMS Supported)**

This option is used to define the video off method. “Blank Screen” mode means that after the computer enters power saving mode, only the monitor will close, however, the vertical and horizontal scanning movement of the screen continues. When you select the “V/H SYNC + Blank” mode the vertical and horizontal scanning movement of screen stops when the computer enters power saving mode. “DPMS Supported” mode is a new screen power management system, and it needs to be supported by the monitor you’re using.
- ❖ **Switch Function (Default: Break/Wake)**

This option is used to enable or disable switch function to wake up. The setting values are Break/Wake and disabled.
- ❖ **MODEM Use IRQ (Default: AUTO)**

This option is used to set the IRQ in which the modem can use. The system will automatically wake up when the modem receives an incoming call.
- ❖ **Hot Key Function As (Default: Power Off)**

The option is used to define the hot key function. The available setting values are Disabled, Power off, Suspend.
- ❖ **HDD Off After (Default: Disabled)**

This option is used to define the continuous HDD idle time before the HDD enters power saving mode. The setting values are Disabled and 1 Min -15 Min.
- ❖ **Power Button Override (Default: Instant Off)**

This option is used to set the power down method. This function is only valid for systems using an ATX power supply.  
When “Instant Off” is selected, press the power switch to immediately turn off power.  
When “Delay 4 Sec” is selected, press and hold the power button for four seconds to turn off power.
- ❖ **Power State Resume Control (Default: Always Off)**

This option is used to control power resume state. The available setting values are Always Off, Always On, Keep Pre-State.
- ❖ **PM Wake Up Events**

Press enter to set the items of PM wake up Events. Please refer to page 47.
- ❖ **Delay Prior to Thermal (Default: None)**

This option is used to set the delay time before the CPU enters auto thermal mode. The setting values are: None, 1Min, 2 Min, 4 Min, 8 Min, 16 Min, 32 Min, 64 Min.

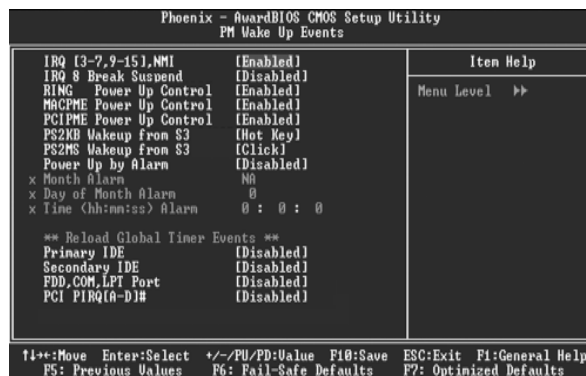

PM Wake Up Events Menu

- ❖ IRQ [3-7,9-15], NMI (Default: Enabled)  
This option is used to enable or disable IRQ[3-7,9-15], NMI.
- ❖ IRQ 8 Break Suspend (Default: Disabled)  
This option is used to enable or disable IRQ8 break suspend.
- ❖ RING Power Up Control (Default: Enabled)  
If this option is enable, it allows the system to resume from a software power down or power saving mode whenever there is an incoming call to an installed fax/modem. This function needs to be supported by the relevant hardware and software. The setting values are Disabled and Enabled.
- ❖ MACPME Power Up Control (Default: Enabled)  
This option is used to enable or disable the system to be waken up by onboard LAN.
- ❖ PCIPME Power Up Control (Default: Enabled)  
This option is used to enable or disable the system to be waken up by PCI card.
- ❖ PS2KB Wakeup from S3 (Default: Hot Key)  
This option is used to set which action will wake up PS/2 keyboard from S3 status. The setting values are Any Key, Hot Key, Password.
- ❖ PS2MS Wakeup from S3 (Default: Click)  
This option is used to set which action will wake up PS/2 mouse from S3 status. The setting values are Disabled, Click, Move & Click.
- ❖ Power Up by Alarm (Default: Disabled)  
This option is used to set the timing of the start-up function. In order to use this function, the start-up password function must be canceled. Also, the PC power source must not be turned off. The setting values are Disabled and Enabled.

❖ Month Alarm

This option is used to set the timing for the start-up month. The setting values contain 0 - 12 and NA.

❖ Day of Month Alarm

This option is used to set the timing for the start-up day of the month. The setting values contain 0 - 31.

❖ Time (hh:mm:ss) Alarm

This option is used to set the timing for the start-up time. The setting values contain hh:0 – 23; mm:0 – 59; ss:0 – 59.

❖ Primary/Secondary IDE (Default: Disabled)

When these items are enabled, the system will restart the power saving timeout counters when any activity is detected on any of the drives or devices on the primary or secondary IDE channels. The setting values are Disabled and Enabled.

❖ FDD, COM, LPT Port (Default: Disabled)

When this option is enabled, the system will restart the power saving timeout counters when any activity is detected on the floppy disk drive, serial ports, or the parallel port.

❖ PCI PIRQ [A-D]# (Default: Disabled)

When this option is disabled, any PCI device set as the master will not power on the system.



PnP/PCI Configurations

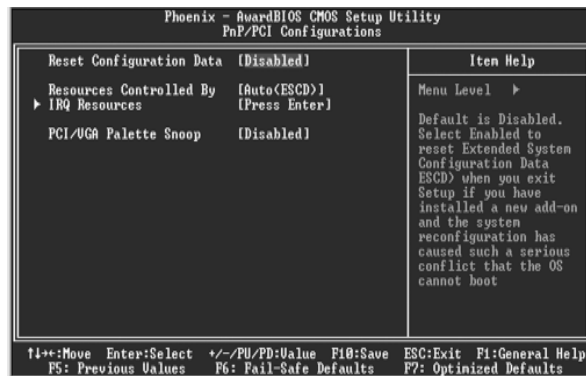

PnP/PCI Configurations Menu

- ❖ Reset Configuration Data (Default: Disabled)
 

This option is used to set whether the system is permitted to automatically distribute IRQ DMA and I/O addresses when each time that the machine is turned on. The setting values are Disabled and Enabled.
- ❖ Resources Controlled By (Default: Auto(ESCD))
 

This option is used to define the system resource control scheme. If all cards you use support PnP, then select Auto (ESCD) and the BIOS automatically distributes interruption resources. If you install ISA cards not supporting PnP, you will need to select “Manual” and manually adjust interruption resources in the event of hardware conflicts. However, since this motherboard has no ISA slot, this option does not apply.
- ❖ IRQ Resources
 

Press the <Enter> key, then manually set IRQ resources.
- ❖ PCI/VGA Palette Snoop (Default: Disabled)
 

If you use a non-standard VGA card, use this option to solve graphic acceleration card or MPEG audio card problems (e.g., colors not accurately displayed). The setting values are Disabled and Enabled.

PC Health Status

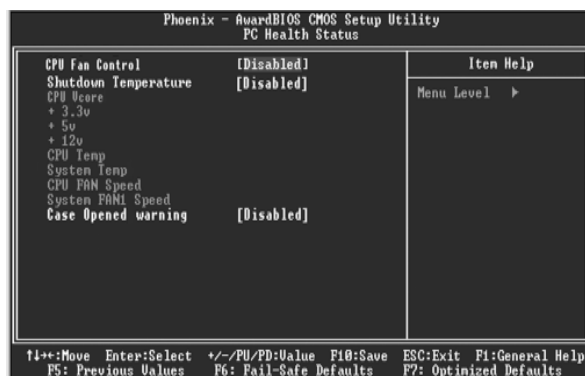

PC Health Status Menu

- ❖ CPU Fan Control (Default: Disabled)  
This option is used to disable or enable CPU fan control function. The setting values are Enabled, Disabled.
- ❖ Shutdown Temperature (Default: Disabled)  
This option is used to set the system temperature upper limit. When the temperature exceeds the setting value, the motherboard will automatically cut off power to the computer. The setting values are 60°C/140°F, 65°C/149°F, 70°C/158°F, Disabled.
- ❖ CPU Vcore/+3.3v/+5v/+12v  
The current voltages will be automatically detected by the system.
- ❖ CPU Temp  
The current CPU temperature will be automatically detected by the system.
- ❖ **System Temp**  
The system temperature will be automatically detected by the system.
- ❖ CPU FAN Speed  
The CPU fan speed will be automatically detected by the system.
- ❖ System FAN Speed  
The system fan speed will be automatically detected by the system.
- ❖ Case Opened Warning (Default: Disabled)  
This option is used to enable or disable case opened warning function. The setting values are Disabled and Enabled.

### Frequency/Voltage Control

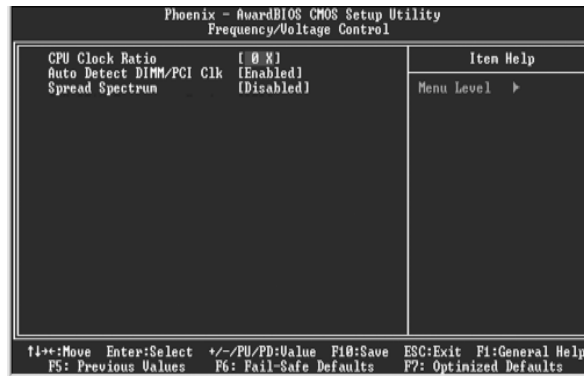

#### Frequency/Voltage Control Menu

- ❖ CPU Clock Ratio (Default: based on CPU specifications)  
This option is used to set the ratio of an unlocked CPU. Using different CPU, the setting values are different.  
Note: this option is invisible for locking frequency CPU.
- ❖ Auto Detect DIMM/PCI Clk (Default: Enabled)  
This option is used to set whether the clock of an unused PCI/DIMM slot will be disabled to reduce electromagnetic interference. The setting values are: Disabled and Enabled.
- ❖ Spread Spectrum (Default: Disabled)  
If you enable spread spectrum, it can significantly reduce the EMI (Electro-Magnetic Interference) generated by the system.

#### ⚡ Warning:

Be sure your selection is right. CPU overclock will be dangerous!  
We will not be responsible for any damages caused.

### Load Fail-Safe Defaults

Press <Enter> to select this option. A dialogue box will pop up that allows you to load the default BIOS settings. Select <Y> and then press <Enter> to load the defaults. Select <N> and press <Enter> to exit without loading. The defaults set by BIOS set the basic system functions in order to ensure system stability. But if your computer cannot POST properly, you should load the fail-safe defaults to restore the original settings. Then carry out failure testing. If you only want to load the defaults for a single option, you can select the desired option the <F6> key.

### Load Optimized Defaults

Select this option and press <Enter>, and a dialogue box will pop up to let you load the optimized BIOS default settings. Select <Y> and then press <Enter> to load the optimized defaults. Select <N> and press <Enter> to exit without loading. The defaults set by BIOS are the optimized performance parameters for the system, to improve the performance of your system components. However, if the optimized performance parameters are not supported by your hardware devices, it will likely cause system reliability and stability issues. If you only want to load the optimized default for a single option, select the desired option and press the <F7> key.

### Set Supervisor/User Password

The access rights and permissions associated with the Supervisor password are higher than those of a regular User password. The Supervisor password can be used to start the system or modify the CMOS settings. The User password can also start the system. While the User password can be used to view the current CMOS settings, these settings cannot be modified using the User password. When you select the Set Supervisor/User Password option, the following message will appear in the center of the screen, which will help you to set the password:

Enter Password:

Enter your password, not exceeding 8 characters, then press <Enter>. The password you enter will replace any previous password. When prompted, key in the new password and press <Enter>.

If you do not want to set a password, just press <Enter> when prompted to enter a password, and in the screen the following message will appear. If no password is keyed in, any user can enter the system and view/modify the CMOS settings.

Password Disabled!!

Press any key to continue ...

Under the menu “Advanced BIOS Features Setup”, if you select “System” from the Security Option, you will be prompted to enter a password once the system is started or whenever you want to enter the CMOS setting program. If the incorrect password is entered, you will not be permitted to continue.

Under the menu “Advanced BIOS Features Setup”, if you select “Setup” from the Security Option, you will be prompted to enter a password only when you enter the CMOS setting program.

### Save & Exit Setup

When you select this option and press <Enter>, the following message will appear in the center of the screen:

SAVE to CMOS and EXIT (Y/N)?Y

Press <Y> to save your changes in CMOS and exit the program; press <N> or <ESC> to return to the main menu.

### Exit Without Saving

If you select this option and press <Enter>, the following message will appear in the center of the screen:

Quit Without Saving (Y/N)?N

Press <Y> to exit CMOS without saving your modifications; press <N> or <ESC> to return to the main menu.

# Chapter 4

The utility CD that came with the motherboard contains useful software and several utility drivers that enhance the motherboard features.

This chapter includes the following information:

- ❖ Utility CD content
- ❖ Start to install drivers

### Utility CD content

This motherboard comes with one Utility CD. To begin using the CD, simply insert the CD into your CD-ROM drive. The CD will automatically display the main menu screen.

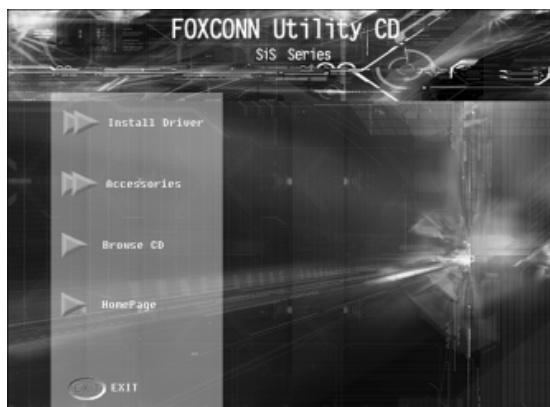

#### 1. Install Driver

Using this choice, you can install all the drivers for your motherboard. You should install the drivers in order and restart your computer after the drivers installed.

- |                 |                             |
|-----------------|-----------------------------|
| A. IDE Driver   | B. SiS SATA RAID (optional) |
| C. AGP Driver   | D. VGA Driver (optional)    |
| E. DirectX 9.0b | F. USB 2.0 Driver           |
| G. Audio Driver | H. LAN Driver               |

#### 2. Accessories

Use this option to install additional software programs.

##### A. SuperUtility

###### a. SuperLogo

SuperLogo can display user-designed graphics and pictures, such as a company logo or personal photos, thus making your PC more personalized and friendly.

###### b. SuperStep

Superstep is a powerful and easy-to-operate tool for overclocking. You can quickly increase your CPU's working frequency through its user-friendly interface. It will enhance your CPU's performance and meet all kinds of DIY requirements.

###### c. SuperUpdate

SuperUpdate function can help to update the BIOS through internet directly.

##### B. Adobe Reader

##### C. Norton Internet Security

### 3. Browse CD

Click here to browse CD content.

### 4. Homepage

Click here to visit Foxconn motherboard homepage.

 Note:

1. Install the latest patch first if your OS is Windows XP or Windows 2000.
2. Follow the CD screen order to install your motherboard drivers.

### Start to Install drivers

Select <Install Driver>, and click to enter the install driver screen. You can select the driver that you want to install and begin the setup steps.

 Note:

The following setup steps are based on Windows XP environment. There may be some differences with other operating systems.

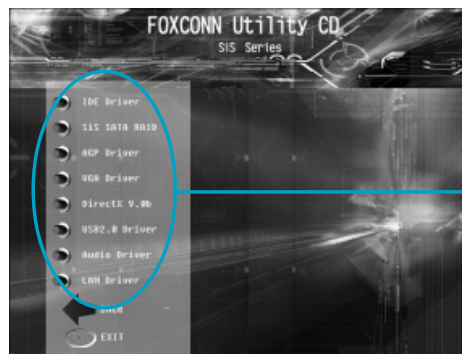

Follow screen order to install the motherboard drivers.