

P5G41C-M LX

Motherboard

ASUS®

E5284

First Edition V1

January 2010

Copyright © 2010 ASUSTeK Computer Inc. All Rights Reserved.

No part of this manual, including the products and software described in it, may be reproduced, transmitted, transcribed, stored in a retrieval system, or translated into any language in any form or by any means, except documentation kept by the purchaser for backup purposes, without the express written permission of ASUSTeK Computer Inc. ("ASUS").

Product warranty or service will not be extended if: (1) the product is repaired, modified or altered, unless such repair, modification or alteration is authorized in writing by ASUS; or (2) the serial number of the product is defaced or missing.

ASUS PROVIDES THIS MANUAL "AS IS" WITHOUT WARRANTY OF ANY KIND, EITHER EXPRESS OR IMPLIED, INCLUDING BUT NOT LIMITED TO THE IMPLIED WARRANTIES OR CONDITIONS OF MERCHANTABILITY OR FITNESS FOR A PARTICULAR PURPOSE. IN NO EVENT SHALL ASUS, ITS DIRECTORS, OFFICERS, EMPLOYEES OR AGENTS BE LIABLE FOR ANY INDIRECT, SPECIAL, INCIDENTAL, OR CONSEQUENTIAL DAMAGES (INCLUDING DAMAGES FOR LOSS OF PROFITS, LOSS OF BUSINESS, LOSS OF USE OR DATA, INTERRUPTION OF BUSINESS AND THE LIKE), EVEN IF ASUS HAS BEEN ADVISED OF THE POSSIBILITY OF SUCH DAMAGES ARISING FROM ANY DEFECT OR ERROR IN THIS MANUAL OR PRODUCT.

SPECIFICATIONS AND INFORMATION CONTAINED IN THIS MANUAL ARE FURNISHED FOR INFORMATIONAL USE ONLY, AND ARE SUBJECT TO CHANGE AT ANY TIME WITHOUT NOTICE, AND SHOULD NOT BE CONSTRUED AS A COMMITMENT BY ASUS. ASUS ASSUMES NO RESPONSIBILITY OR LIABILITY FOR ANY ERRORS OR INACCURACIES THAT MAY APPEAR IN THIS MANUAL, INCLUDING THE PRODUCTS AND SOFTWARE DESCRIBED IN IT.

Products and corporate names appearing in this manual may or may not be registered trademarks or copyrights of their respective companies, and are used only for identification or explanation and to the owners' benefit, without intent to infringe.

Offer to Provide Source Code of Certain Software

This product may contain copyrighted software that is licensed under the General Public License ("GPL") and under the Lesser General Public License Version ("LGPL"). The GPL and LGPL licensed code in this product is distributed without any warranty. Copies of these licenses are included in this product.

You may obtain the complete corresponding source code (as defined in the GPL) for the GPL Software, and/or the complete corresponding source code of the LGPL Software (with the complete machine-readable "work that uses the Library") for a period of three years after our last shipment of the product including the GPL Software and/or LGPL Software, which will be no earlier than December 1, 2011, either

(1) for free by downloading it from <http://support.asus.com/download>;

or

(2) for the cost of reproduction and shipment, which is dependent on the preferred carrier and the location where you want to have it shipped to, by sending a request to:

ASUSTeK Computer Inc.
Legal Compliance Dept.
15 Li Te Rd.,
Beitou, Taipei 112
Taiwan

In your request please provide the name, model number and version, as stated in the About Box of the product for which you wish to obtain the corresponding source code and your contact details so that we can coordinate the terms and cost of shipment with you.

The source code will be distributed WITHOUT ANY WARRANTY and licensed under the same license as the corresponding binary/object code.

This offer is valid to anyone in receipt of this information.

ASUSTeK is eager to duly provide complete source code as required under various Free Open Source Software licenses. If however you encounter any problems in obtaining the full corresponding source code we would be much obliged if you give us a notification to the email address gp@asus.com, stating the product and describing the problem (please do NOT send large attachments such as source code archives etc to this email address).

Contents

Notices.....	vi
Safety information	vii
About this guide	vii
P5G41C-M LX specifications summary	ix
Chapter 1: Product introduction	
1.1 Welcome!	1-1
1.2 Package contents	1-1
1.3 Special features	1-1
1.3.1 Product highlights	1-1
1.3.2 Innovative ASUS features	1-2
1.4 Before you proceed	1-4
1.5 Motherboard overview	1-5
1.5.1 Placement direction	1-5
1.5.2 Screw holes	1-5
1.5.3 Motherboard layout	1-6
1.5.4 Layout contents.....	1-6
1.6 Central Processing Unit (CPU)	1-7
1.6.1 Installing the CPU	1-7
1.6.2 Installing the CPU heatsink and fan	1-10
1.6.3 Uninstalling the CPU heatsink and fan	1-11
1.7 System memory	1-12
1.7.1 Overview	1-12
1.7.2 Memory configurations.....	1-13
1.7.3 Installing a DIMM	1-19
1.7.4 Removing a DIMM	1-19
1.8 Expansion slots	1-20
1.8.1 Installing an expansion card	1-20
1.8.2 Configuring an expansion card	1-20
1.8.3 PCI slots.....	1-20
1.8.4 PCI Express x1 slot.....	1-20
1.8.5 PCI Express x16 slot.....	1-20
1.9 Jumpers	1-21
1.10 Connectors	1-23
1.10.1 Rear panel connectors	1-23
1.10.2 Internal connectors	1-24

Contents

1.11	Software support	1-30
1.11.1	Installing an operating system	1-30
1.11.2	Support DVD information	1-30
Chapter 2: BIOS information		
2.1	Managing and updating your BIOS	2-1
2.1.1	ASUS Update utility	2-1
2.1.2	ASUS EZ Flash 2	2-2
2.1.3	ASUS CrashFree BIOS	2-3
2.2	BIOS setup program	2-4
2.2.1	BIOS menu screen	2-5
2.2.2	Menu bar	2-5
2.2.3	Navigation keys	2-6
2.2.4	Menu items	2-6
2.2.5	Submenu items	2-6
2.2.6	Configuration fields	2-6
2.2.7	Pop-up window	2-6
2.2.8	Scroll bar	2-6
2.2.9	General help	2-6
2.3	Main menu	2-7
2.3.1	System Time	2-7
2.3.2	System Date	2-7
2.3.3	Primary IDE Master/Slave, SATA1~4	2-7
2.3.4	Storage Configuration	2-8
2.3.5	System Information	2-9
2.4	Advanced menu	2-9
2.4.1	JumperFree Configuration	2-9
2.4.2	CPU Configuration	2-11
2.4.3	Chipset	2-12
2.4.4	Onboard Devices Configuration	2-13
2.4.5	USB Configuration	2-14
2.4.6	PCI PnP	2-15
2.5	Power menu	2-15
2.5.1	Suspend Mode	2-15
2.5.2	ACPI 2.0 Support	2-15
2.5.3	ACPI APIC Support	2-15

Contents

2.5.4	Anti Surge Support	2-15
2.5.5	APM Configuration	2-16
2.5.6	Hardware Monitor	2-16
2.6	Boot menu	2-17
2.6.1	Boot Device Priority	2-17
2.6.2	Boot Settings Configuration	2-17
2.6.3	Security	2-18
2.7	Tools menu	2-20
2.7.1	ASUS EZ Flash 2	2-20
2.7.2	Express Gate	2-20
2.7.3	AI NET 2	2-20
2.8	Exit menu	2-21

Notices

Federal Communications Commission Statement

This device complies with Part 15 of the FCC Rules. Operation is subject to the following two conditions:

- This device may not cause harmful interference, and
- This device must accept any interference received including interference that may cause undesired operation.

This equipment has been tested and found to comply with the limits for a Class B digital device, pursuant to Part 15 of the FCC Rules. These limits are designed to provide reasonable protection against harmful interference in a residential installation. This equipment generates, uses and can radiate radio frequency energy and, if not installed and used in accordance with manufacturer's instructions, may cause harmful interference to radio communications. However, there is no guarantee that interference will not occur in a particular installation. If this equipment does cause harmful interference to radio or television reception, which can be determined by turning the equipment off and on, the user is encouraged to try to correct the interference by one or more of the following measures:

- Reorient or relocate the receiving antenna.
- Increase the separation between the equipment and receiver.
- Connect the equipment to an outlet on a circuit different from that to which the receiver is connected.
- Consult the dealer or an experienced radio/TV technician for help.



The use of shielded cables for connection of the monitor to the graphics card is required to assure compliance with FCC regulations. Changes or modifications to this unit not expressly approved by the party responsible for compliance could void the user's authority to operate this equipment.

Canadian Department of Communications Statement

This digital apparatus does not exceed the Class B limits for radio noise emissions from digital apparatus set out in the Radio Interference Regulations of the Canadian Department of Communications.

This class B digital apparatus complies with Canadian ICES-003.

REACH

Complying with the REACH (Registration, Evaluation, Authorisation, and Restriction of Chemicals) regulatory framework, we published the chemical substances in our products at ASUS REACH website at <http://green.asus.com/english/REACH.htm>.



DO NOT throw the motherboard in municipal waste. This product has been designed to enable proper reuse of parts and recycling. This symbol of the crossed out wheeled bin indicates that the product (electrical and electronic equipment) should not be placed in municipal waste. Check local regulations for disposal of electronic products.



DO NOT throw the mercury-containing button cell battery in municipal waste. This symbol of the crossed out wheeled bin indicates that the battery should not be placed in municipal waste.

Safety information

Electrical safety

- To prevent electric shock hazard, disconnect the power cable from the electric outlet before relocating the system.
- When adding or removing devices to or from the system, ensure that the power cables for the devices are unplugged before the signal cables are connected. If possible, disconnect all power cables from the existing system before you add a device.
- Before connecting or removing signal cables from the motherboard, ensure that all power cables are unplugged.
- Seek professional assistance before using an adapter or extension cord. These devices could interrupt the grounding circuit.
- Ensure that your power supply is set to the correct voltage in your area. If you are not sure about the voltage of the electrical outlet you are using, contact your local power company.
- If the power supply is broken, do not try to fix it by yourself. Contact a qualified service technician or your retailer.

Operation safety

- Before installing the motherboard and adding devices on it, carefully read all the manuals that came with the package.
- Before using the product, ensure that all cables are correctly connected and the power cables are not damaged. If you detect any damage, contact your dealer immediately.
- To avoid short circuits, keep paper clips, screws, and staples away from connectors, slots, sockets and circuitry.
- Avoid dust, humidity, and temperature extremes. Do not place the product in any area where it may become wet.
- Place the product on a stable surface.
- If you encounter technical problems with the product, contact a qualified service technician or your retailer.

About this guide

This user guide contains the information you need when installing and configuring the motherboard.

How this guide is organized

This guide contains the following parts:

- **Chapter 1: Product introduction**
This chapter describes the features of the motherboard and the new technology it supports.
- **Chapter 2: BIOS information**
This chapter tells how to change system settings through the BIOS Setup menus. Detailed descriptions of the BIOS parameters are also provided.

Conventions used in this guide

To ensure that you perform certain tasks properly, take note of the following symbols used throughout this manual.



DANGER/WARNING: Information to prevent injury to yourself when trying to complete a task.



CAUTION: Information to prevent damage to the components when trying to complete a task.



IMPORTANT: Instructions that you **MUST** follow to complete a task.



NOTE: Tips and additional information to help you complete a task.

Where to find more information

Refer to the following sources for additional information and for product and software updates.

1. ASUS websites

The ASUS website provides updated information on ASUS hardware and software products. Refer to the ASUS contact information.

2. Optional documentation

Your product package may include optional documentation, such as warranty flyers, that may have been added by your dealer. These documents are not part of the standard package.

Typography

Bold text

Indicates a menu or an item to select.

Italics

Used to emphasize a word or a phrase.

<Key>

Keys enclosed in the less-than and greater-than sign means that you must press the enclosed key.

Example: <Enter> means that you must press the Enter or Return key.

<Key1>+<Key2>+<Key3>

If you must press two or more keys simultaneously, the key names are linked with a plus sign (+).

Example: <Ctrl>+<Alt>+<D>

P5G41C-M LX specifications summary

CPU	LGA775 socket for Intel® Core™2 Quad / Core™2 Extreme / Core™2 Duo / Pentium® dual-core / Celeron® dual-core / Celeron® processors Compatible with Intel® 05B/05A/06 processors Supports Intel® 45nm multi-core CPU * Refer to www.asus.com for Intel® CPU support list.
Chipset	Northbridge: Intel® G41 Southbridge: Intel® ICH7
Front Side Bus	1333/1066/800 MHz
Memory	Dual channel memory architecture <ul style="list-style-type: none"> - 2 x 240-pin DIMM sockets support unbuffered non-ECC 1333(O.C.)/1066/800 MHz DDR3 memory modules - 2 x 240-pin DIMM sockets support unbuffered non-ECC 1066(O.C.)/800/667 MHz DDR2 memory modules - Supports up to 8GB system memory <p>* Refer to www.asus.com for the latest Memory QVL (Qualified Vendors Lists).</p> <p>** DDR2 and DDR3 memory modules cannot be used simultaneously. Use DDR3 memory modules on the black slots and DDR2 memory modules on the blue slots.</p> <p>** When you install a total memory of 4GB or more, Windows® 32-bit operating system may only recognize less than 3GB. We recommend a maximum of 3GB system memory if you are using a Windows® 32-bit operating system.</p>
Graphics	Integrated Intel® GMA X4500 GPU Maximum shared memory of 1GB Supports RGB with max. resolution of 2048 x 1536 (@ 75Hz) Supports Microsoft® DirectX® 10
Expansion slots	1 x PCIe x16 slot 1 x PCIe x1 slot 2 x PCI slots
Storage	1 x Ultra DMA 100/66/33 connector 4 x Serial ATA 3Gb/s connectors
LAN	PCIe Gigabit LAN
Audio	VT1708S High Definition Audio 8-channel CODEC * Use the chassis with HD audio module in the front panel to support 8-channel audio output. Supports Jack-detection and Multi-Streaming technologies Supports S/PDIF Out interface
USB	Supports up to 8 USB 2.0/1.1 ports (4 ports at mid-board, 4 ports at the back panel)

(continued on the next page)

P5G41C-M LX specifications summary

ASUS exclusive overclocking features	SFS (Stepless Frequency Selection): <ul style="list-style-type: none"> - FSB tuning from 200MHz to 800MHz at 1MHz increment Overclocking Protection: <ul style="list-style-type: none"> - ASUS C.P.R. (CPU Parameter Recall)
ASUS unique features	ASUS CrashFree BIOS 3 ASUS AI NET 2 ASUS Q-Fan ASUS EZ Flash 2 ASUS MyLogo 2 ASUS Anti-Surge Protection ASUS Turbo Key ASUS Express Gate ASUS EPU-L
Back panel I/O ports	1 x PS/2 keyboard port 1 x PS/2 mouse port 1 x LPT port 1 x COM port 1 x VGA port 1 x LAN (RJ-45) port 4 x USB 2.0/1.1 ports 3 x audio jacks
Internal connectors	2 x USB 2.0/1.1 connectors support additional 4 USB 2.0/1.1 ports 1 x IDE connector 4 x Serial ATA connectors 1 x Front panel audio connector 1 x System panel connector 1 x S/PDIF Out connector 1 x Internal speaker connector 1 x CPU fan connector 1 x Chassis fan connector 1 x 24-pin EATX power connector 1 x 4-pin ATX 12V power connector
BIOS	8Mb Flash ROM, AMI BIOS, PnP, DMI 2.0, WfM 2.0, ACPI 2.0a, SM BIOS 2.5
Manageability	WOL, PXE, WOR by Ring, PME Wake up
Accessories	1 x Ultra DMA 133/100/66 cable 2 x Serial ATA cables 1 x I/O shield 1 x User Manual
Support DVD	Drivers ASUS PC Probe II ASUS Update Anti-Virus software (OEM version)
Form factor	uATX form factor: 9.6 in x 8.5 in (24.4 cm x 21.6 cm)

* Specifications are subject to change without notice.

Chapter 1

Product introduction

1.1 Welcome!

Thank you for buying an ASUS® P5G41C-M LX motherboard!

The motherboard delivers a host of new features and latest technologies, making it another standout in the long line of ASUS quality motherboards!

Before you start installing the motherboard, and hardware devices on it, check the items in your package with the list below.

1.2 Package contents

Check your motherboard package for the following items.

Motherboard	ASUS P5G41C-M LX motherboard
Cables	2 x Serial ATA cables 1 x Ultra DMA 133/100/66 cable
Accessories	1 x I/O shield
Application DVD	ASUS motherboard support DVD
Documentation	User Manual



If any of the above items is damaged or missing, contact your retailer.

1.3 Special features

1.3.1 Product highlights



Intel® Core™2 Extreme / Core™2 Quad / Core™2 Duo CPU support

This motherboard supports Intel® LGA775 Core™ 2 Extreme / Core™ 2 Quad/ Core™ 2 Duo processors, which are excellent for multitasking, multimedia, and enthusiastic gamers with 1333/1066/800 MHz FSB. This motherboard also supports Intel® CPUs in the 45nm manufacturing process.



Intel® G41 Chipset

The Intel® G41 Express Chipset is designed to support dual-channel DDR3 1333 (overclocking)/1066/800 architecture, 1333/1066/800 Front Side Bus (FSB), PCIe 1.1, and multi-core CPUs. It especially includes Intel® Fast memory bandwidth and reduces the latency of the memory accesses.



Dual channel DDR3 1333 (O.C.)/1066/800 support

This motherboard supports DDR3 memory that features data transfer rates of 1333 (O.C.)/1066/800 MHz providing great performance for 3D graphics and other memory-demanding applications.



Serial ATA 3Gb/s technology

This motherboard supports hard drives based on the Serial ATA (SATA) 3Gb/s storage specifications, delivering enhanced scalability and doubling the bus bandwidth for high-speed data saving and retrieval.



Gigabit LAN solution

The onboard LAN controller is a highly integrated Gb LAN controller. It is enhanced with an ACPI management function to provide efficient power management for advanced operating systems.

1.3.2 Innovative ASUS features



ASUS EPU

ASUS EPU (Energy Processing Unit) provides total system power management by detecting the current PC loading and intelligently moderating power in real-time. It automatically provides the most appropriate power usage to save power and money.



Turbo Key

ASUS Turbo Key allows you to turn the PC power button into an overclocking button. After you easy setup, Turbo Key boosts performances without interrupting ongoing work or games, simply through pressing the button.



ASUS Q-FAN

ASUS Q-FAN technology intelligently and automatically adjusts CPU fan speed according to system load and temperature, enabling users to work in distraction-free environment with minimal noise.



ASUS Anti-Surge Protection

This special design prevents expensive devices and the motherboard from damage caused by power surges from switching power supply (PSU).



ASUS Express Gate

Express Gate is an ASUS exclusive OS, which lets you instantly access the Internet and key applications before entering the Windows® OS.



- ASUS Express Gate supports installation on SATA HDDs, USB HDDs and flash drives with at least 1.2GB free disk space. When installing it on USB HDDs or flash drives, connect the drives to the motherboard USB port before turning on the computer.
- The actual boot time depends on the system configuration.
- ASUS Express Gate supports file uploading from SATA HDDs, ODDs and USB drives. It supports file downloading to USB drives only.



ASUS MyLogo2™

This feature allows you to convert your favorite photo into a 256-color boot logo for a more colorful and vivid image on your screen.



ASUS CrashFree BIOS 3

ASUS CrashFree BIOS 3 is an auto-recovery tool that allows you to restore a corrupted BIOS file using the bundled support DVD or USB flash disk that contains the latest BIOS file.



ASUS EZ Flash 2

ASUS EZ Flash 2 is a utility that allows you to update the BIOS without using an OS-based utility.



ASUS AI NET2

ASUS AI NET2 remotely detects the cable connection immediately after turning on the system, and any faulty cable connections are reported back up to 100 meters at 1 meter accuracy.



C.P.R. (CPU Parameter Recall)

The BIOS C.P.R. feature automatically restores the CPU default settings when the system hangs due to overclocking failure. C.P.R. eliminates the need to open the system chassis and clear the RTC data. Simply shut down and reboot the system, and the BIOS automatically restores the CPU parameters to their default settings.



Green ASUS

This motherboard and its packaging comply with the European Union's Restriction on the use of Hazardous Substances (RoHS). This is in line with the ASUS vision of creating environment-friendly and recyclable products/packaging to safeguard consumers' health while minimizing the impact on the environment.

1.4 Before you proceed

Take note of the following precautions before you install motherboard components or change any motherboard settings.



- Unplug the power cord from the wall socket before touching any component.
- Before handling components, use a grounded wrist strap or touch a safely grounded object or a metal object, such as the power supply case, to avoid damaging them due to static electricity.
- Hold components by the edges to avoid touching the ICs on them.
- Whenever you uninstall any component, place it on a grounded antistatic pad or in the bag that came with the component.
- Before you install or remove any component, ensure that the ATX power supply is switched off or the power cord is detached from the power supply. Failure to do so may cause severe damage to the motherboard, peripherals, or components.

Onboard LED

The motherboard comes with a standby power LED that lights up to indicate that the system is ON, in sleep mode, or in soft-off mode. This is a reminder that you must shut down the system and unplug the power cable before removing or plugging in any motherboard component. The illustration below shows the location of the onboard LED.

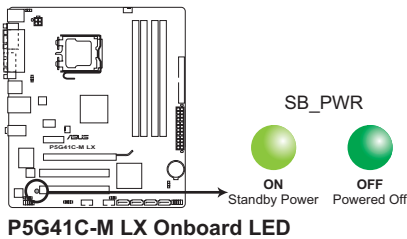

1.5 Motherboard overview

Before you install the motherboard, study the configuration of your chassis to ensure that the motherboard fits into it.



Ensure that you unplug the power cord before installing or removing the motherboard. Failure to do so can cause you physical injury and damage motherboard components.

1.5.1 Placement direction

When installing the motherboard, ensure that you place it into the chassis in the correct orientation. The edge with external ports goes to the rear part of the chassis as indicated in the image below.

1.5.2 Screw holes

Place six screws into the holes indicated by circles to secure the motherboard to the chassis.



Do not overtighten the screws! Doing so can damage the motherboard.

Place this side towards the rear of the chassis

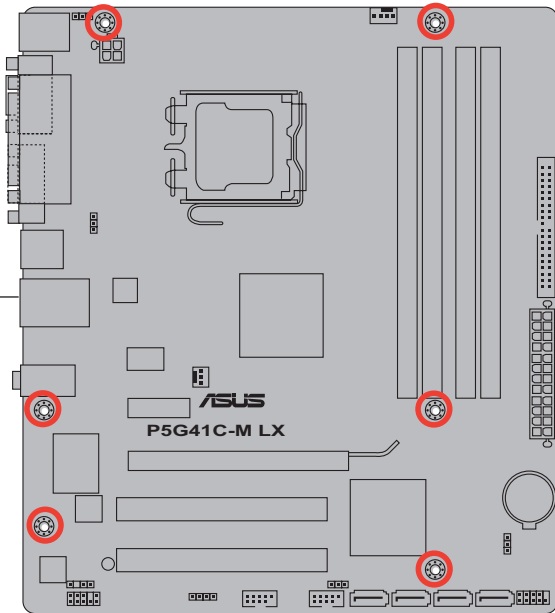

1.5.3 Motherboard layout

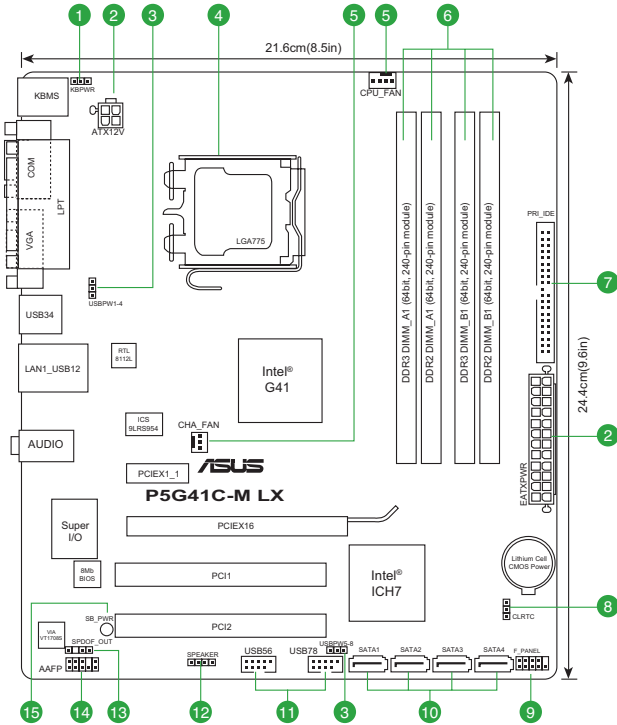

1.5.4 Layout contents

Connectors/Jumpers/Slots/LED	Page	Connectors/Jumpers/Slots/LED	Page
1. Keyboard power (3-pin KBPWR)	1-22	9. System panel connector (10-1 pin F_PANEL)	1-29
2. ATX power connectors (24-pin EATXPWR, 4-pin ATX12V)	1-26	10. Serial ATA connectors (7-pin SATA1-4)	1-27
3. USB device wake-up (3-pin USBPW1-4, 3-pin USBPW5-8)	1-22	11. USB connectors (10-1 pin USB56, USB78)	1-27
4. Intel LGA775 CPU socket	1-7	12. Speaker connector (4-pin SPEAKER)	1-29
5. CPU and chassis fan connectors (4-pin CPU_FAN, 3-pin CHA_FAN)	1-28	13. Digital audio connector (4-1 pin SPDIF_OUT)	1-28
6. DIMM slots	1-12	14. Front panel audio connector (10-1 pin AAFP)	1-24
7. IDE connector (40-1 pin PRI_IDE)	1-25	15. Onboard LED (SB_PWR)	1-4
8. Clear RTC RAM (3-pin CLRTC)	1-21		

1.6 Central Processing Unit (CPU)

The motherboard comes with a surface mount LGA775 socket designed for the Intel® Core™2 Extreme / Core™2 Quad / Core™2 Duo / Pentium® dual-core / Celeron® dual-core / Celeron® processors



- Unplug all power cables before installing the CPU.
- Connect the CPU fan cable to the CPU_FAN connector and chassis fan cable to the CHA_FAN connector to ensure system stability.



- Upon purchase of the motherboard, ensure that the PnP cap is on the socket and the socket contacts are not bent. Contact your retailer immediately if the PnP cap is missing, or if you see any damage to the PnP cap/socket contacts/motherboard components. ASUS will shoulder the cost of repair only if the damage is shipment/transit-related.
- Keep the cap after installing the motherboard. ASUS will process Return Merchandise Authorization (RMA) requests only if the motherboard comes with the cap on the LGA775 socket.
- The product warranty does not cover damage to the socket contacts resulting from incorrect CPU installation/removal, or misplacement/loss/incorrect removal of the PnP cap.



The motherboard supports Intel® LGA775 processors with the Intel® Enhanced Intel SpeedStep® Technology (EIST) and Hyper-Threading Technology.

1.6.1 Installing the CPU

To install a CPU:

1. Locate the CPU socket on the motherboard.

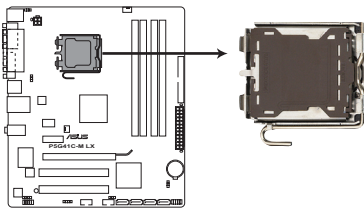

P5G41C-M LX CPU socket 775



Before installing the CPU, ensure that the cam box is facing towards you and the load lever is on your left.

2. Press the load lever with your thumb (A), then move it to the left (B) until it is released from the retention tab.



To prevent damage to the socket pins, do not remove the PnP cap unless you are installing a CPU.

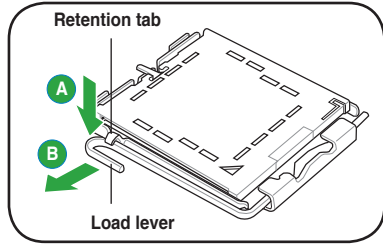

3. Lift the load lever in the direction of the arrow to a 135° angle.
4. Lift the load plate with your thumb and forefinger to a 100° angle (4A), then push the PnP cap from the load plate window to remove (4B).

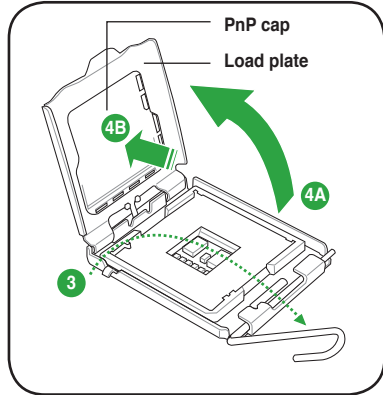

5. Position the CPU over the socket, ensuring that the gold triangle is on the bottom-left corner of the socket then fit the socket alignment key into the CPU notch.

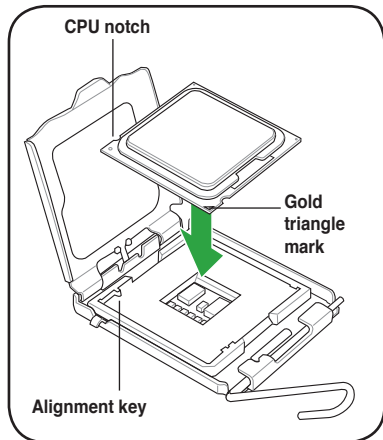

6. Apply some Thermal Interface Material to the exposed area of the CPU that the heatsink will be in contact with, ensuring that it is spread in an even thin layer.



Some heatsinks come with pre-applied thermal paste. If so, skip this step.

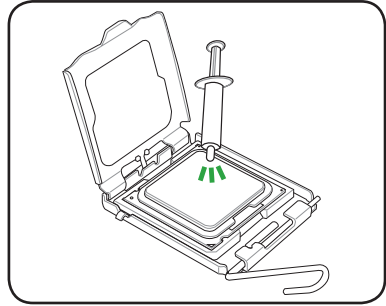

DO NOT eat the Thermal Interface Material. If it gets into your eyes or touches your skin, ensure that you wash it off immediately, and seek professional medical help.



To prevent contaminating the paste, **DO NOT** spread the paste with your finger directly.

7. Close the load plate (A), then push the load lever (B) until it snaps into the retention tab.

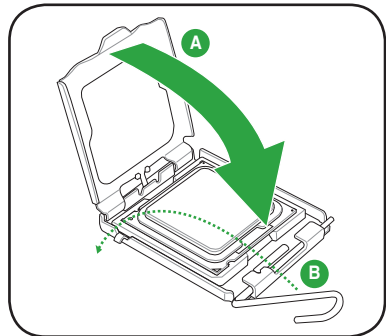

1.6.2 Installing the CPU heatsink and fan

The Intel® LGA775 processor requires a specially designed heatsink and fan assembly to ensure optimum thermal condition and performance.



- When you buy a boxed Intel® processor, the package includes the CPU fan and heatsink assembly. If you buy a CPU separately, ensure that you use only Intel®-certified multi-directional heatsink and fan.
- Your Intel® LGA775 heatsink and fan assembly comes in a push-pin design and requires no tool to install.
- If you purchased a separate CPU heatsink and fan assembly, ensure that you have properly applied Thermal Interface Material to the CPU heatsink or CPU before you install the heatsink and fan assembly.



Ensure that you have installed the motherboard to the chassis before you install the CPU fan and heatsink assembly.

To install the CPU heatsink and fan:

1. Place the heatsink on top of the installed CPU, ensuring that the four fasteners match the holes on the motherboard.



Orient the heatsink and fan assembly such that the CPU fan cable is closest to the CPU fan connector.

2. Push down two fasteners at a time in a diagonal sequence to secure the heatsink and fan assembly in place.

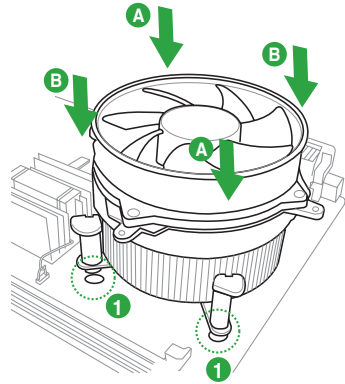
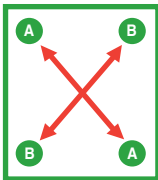

The type of CPU heatsink and fan assembly may differ, but the installation steps and functions should remain the same. The illustration above is for reference only.

3. Connect the CPU fan cable to the connector on the motherboard labeled CPU_FAN.

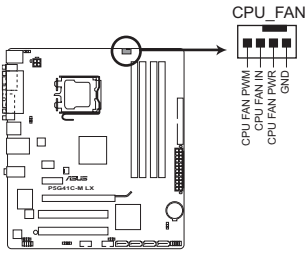

P5G41C-M LX CPU fan connector



Do not forget to connect the CPU fan connector! Hardware monitoring errors can occur if you fail to plug this connector.

1.6.3 Uninstalling the CPU heatsink and fan

To uninstall the CPU heatsink and fan:

1. Disconnect the CPU fan cable from the connector on the motherboard.
2. Rotate each fastener counterclockwise.
3. Pull up two fasteners at a time in a diagonal sequence to disengage the heatsink and fan assembly from the motherboard.

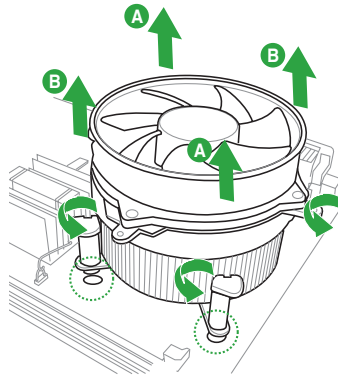
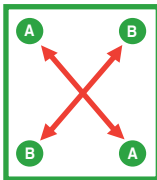

- Carefully remove the heatsink and fan assembly from the motherboard.
- Rotate each fastener clockwise to ensure correct orientation when reinstalling.

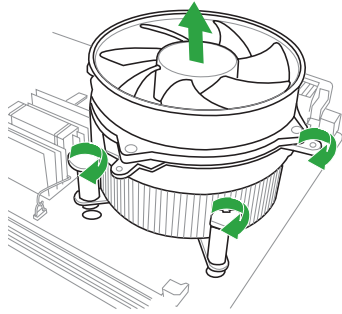

1.7 System memory

1.7.1 Overview

The motherboard comes with two Double Data Rate 3 (DDR3) and two Double Data Rate 3 (DDR2) Dual Inline Memory Modules (DIMM) sockets. The figure illustrates the location of the DIMM sockets:

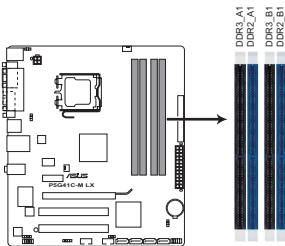

P5G41C-M LX 240-pin DIMM sockets

Channel	Sockets
Channel A	DDR3_A1 and DDR2_A1
Channel B	DDR3_B1 and DDR2_B1

1.7.2 Memory configurations

You may install 512MB, 1GB, 2GB, and 4GB unbuffered non-ECC DDR3 DIMMS into the black sockets or 512MB, 1GB, 2GB, and 4GB unbuffered non-ECC DDR2 DIMMS into the blue sockets



- DO NOT use DDR2 and DDR3 memory modules simultaneously.
- You may install varying memory sizes in Channel A and Channel B. The system maps the total size of the lower-sized channel for the dual-channel configuration. Any excess memory from the higher-sized channel is then mapped for single-channel operation.
- Always install DIMMs with the same CAS latency. For optimum compatibility, it is recommended that you obtain memory modules from the same vendor.
- Due to the memory address limitation on 32-bit Windows® OS, when you install 4GB or more memory on the motherboard, the actual usable memory for the OS can be about 3GB or less. For effective use of memory, we recommend that you do any of the following:
 - Use a maximum of 3GB system memory if you are using a 32-bit Windows® OS.
 - Install a 64-bit Windows® OS when you want to install 4GB or more memory on the motherboard.
- This motherboard does not support DIMMs made up of 256 megabits (Mb) chips or less.



- The default memory operation frequency is dependent on its Serial Presence Detect (SPD), which is the standard way of accessing information from a memory module. Under the default state, some memory modules for overclocking may operate at a lower frequency than the vendor-marked value.
- For system stability, use a more efficient cooling system to support a full memory load (2 DIMMs) or overclocking conditions.

P5G41C-M LX Motherboard Qualified Vendors Lists (QVL)

DDR3-1066 MHz capability

Vendor	Part No.	Size	SS/DS	Chip Brand	Chip NO.	Timing	Voltage	DIMM support (Optional)	
								A*	B*
Crucial	CT12864BA1067.8FF	1024MB	SS	Micron	9GF22D9KPT	7	-	•	•
Crucial	CT25664BA1067.16FF	2048MB	DS	Micron	9HF22D9KPT	7	-	•	•
ELPIDA	EBJ10UE8EDF0-AE-F	1024MB	SS	ELPIDA	J1108EDSE-DJ-F	-	1.35V(low voltage)	•	•
ELPIDA	EBJ51UD8BAFA-AC-E	512MB	SS	Elpida	J5308BASE-AC-E	-	-	•	•
ELPIDA	EBJ51UD8BAFA-AE-E	512MB	SS	Elpida	J5308BASE-AC-E	-	-	•	•
ELPIDA	EBJ11UD8BAFA-AE-E	1024MB	DS	Elpida	J5308BASE-AC-E	-	-	•	•
ELPIDA	EBJ21UE8EDF0-AE-F	2048MB	DS	ELPIDA	J1108EDSE-DJ-F	-	1.35V(low voltage)	•	•
KINGSTON	KVR1066D3N7/1G	1024MB	SS	Kingston	D1288JEKAPGA7U	7	1.5V	•	•
KINGSTON	KVR1066D3N7/2G	2048MB	DS	Kingston	D1288JEKAPGA7U	7	1.5V	•	•
Micron	MT8JTF12864AZ-1G1F1	1024MB	SS	Micron	9GF22D9KPT	7	-	•	•
Micron	MT16JTF25664AZ-1G1F1	2048MB	DS	Micron	9HF22D9KPT	7	-	•	•
SAMSUNG	M378B2873EH1-CF8	1024MB	SS	SAMSUNG	SEC 901 HCF8 K4B1G0846E	-	-	•	•
SAMSUNG	M378B5273BH1-CF8	4096MB	DS	SAMSUNG	846 K4B2G0846B-HCF8	-	-	•	•
Elixir	M2Y2G64CBH8CN-BE	2048MB	DS	Elixir	N2CB1G80CN-BE	-	-	•	•
Elixir	M2Y2G64CBHA9N-BE	2048MB	DS	-	-	7-7-7-20	-	•	•
Elixir	M2Y2G64CBHC9N-BE	2048MB	DS	Elixir	-	-	-	•	•
Kingtiger	2GB DIMM PC3-8500	2048MB	DS	Hynix	H5TQ1G83AFP G7C	-	-	•	•

DDR3-1333(O.C.) MHz capability

Vendor	Part No.	Size	SS/ DS	Chip Brand	Chip NO.	Timing	Voltage	DIMM socket support (Optional)	
								A*	B*
A-Data	AD31333001GOU	1024MB	SS	A-Data	AD30908C8D-151C E0906	-	-	*	*
A-Data	AD31333G001GOU	3072MB(Kit of 3)	SS	-	-	8-8-8-24	1.65-1.85V	*	*
A-Data	AD31333002GOU	2048MB	DS	A-Data	AD30908C8D-151C E0903	-	-	*	*
A-Data	AD31333G002GMU	2048MB	DS	-	-	8-8-8-24	1.65-1.85V	*	*
Apacer	78.A1GC6.9L1	2048MB	DS	APACER	AM5D5808DEWSBG	-	-	*	*
CORSAIR	CM3X1024-1333C9DHX	1024MB	SS	-	-	9-9-9-24	1.60V	*	*
CORSAIR	CM3X1024-1333C9	1024MB	SS	-	-	-	-	*	*
CORSAIR	TR3X3G1333C9 G	3072MB(Kit of 3)	SS	-	-	9-9-9-24	1.50V	*	*
CORSAIR	TR3X3G1333C9 G	3072MB(Kit of 3)	SS	-	-	9-9-9-24	1.50V	*	*
CORSAIR	TR3X3G1333C9	3072MB(Kit of 3)	SS	-	-	9	1.5V	*	*
CORSAIR	CM3X1024-1333C9DHX	1024MB	DS	Corsair	-	-	-	*	*
CORSAIR	CM3X2048-1333C9DHX	2048MB	DS	-	-	-	-	*	*
CORSAIR	TW3X4G1333C9 G	4096MB(Kit of 2)	DS	-	-	9-9-9-24	1.50V	*	*
Crucial	CT12864BA1339.8FF	1024MB	SS	Micron	9FF22D9KPT	9	-	*	*
Crucial	BL12864TA1336.8SFB1	2048MB(Kit of 2)	SS	-	-	6-6-6-20	1.8V	*	*
Crucial	CT25664BA1339.16FF	2048MB	DS	Micron	9KF27D9KPT	9	-	*	*
Crucial	BL25664BA1336.16SFB1	4096MB(Kit of 2)	DS	-	-	6-6-6-20	1.8V	*	*
Crucial	BL25664BA1336.16SFB1	4096MB(Kit of 2)	DS	-	-	6-6-6-20	1.8V	*	*
Crucial	BL25664BN1337.16FF (XMP)	6144MB(Kit of 3)	DS	-	-	7-7-7-24	1.65V	*	*
ELPIDA	EBJ10UE8EDF0-DJ-F	1024MB	SS	ELPIDA	J1108EDSE-DJ-F	-	1.35V(low voltage)	*	*
ELPIDA	EBJ21UE8EDF0-DJ-F	2048MB	DS	ELPIDA	J1108EDSE-DJ-F	-	1.35V(low voltage)	*	*
G.SKILL	F3-10600CL8D-2GBHK	1024MB	SS	G.SKILL	-	-	-	*	*
G.SKILL	F3-10600CL9D-2GBPK	1024MB	SS	G.SKILL	-	-	-	*	*
G.SKILL	F3-10666CL7T-3GBPK	3072MB(Kit of 3)	SS	-	-	7-7-7-18	1.5-1.6V	*	*
G.SKILL	F3-10666CL9T-3GBNQ	3072MB(Kit of 3)	SS	-	-	9-9-9-24	1.5-1.6V	*	*
G.SKILL	F3-10600CL7D-2GBPI(XMP)	1024MB	DS	G.SKILL	-	-	-	*	*
G.SKILL	F3-10600CL9D-2GBNQ	1024MB	DS	G.SKILL	-	-	-	*	*
G.SKILL	F3-10666CL8D- 4GBECO(XMP)	4096MB(Kit of 2)	DS	-	-	8-8-8-24	1.35V(low voltage)	*	*
G.SKILL	F3-10666CL8D- 4GBHK(XMP)	4096MB(Kit of 2)	DS	-	-	8-8-8-21	1.5-1.6V	*	*
G.SKILL	F3-10666CL7T- 6GBPK(XMP)	6144MB(Kit of 3)	DS	-	-	7-7-7-18	1.5-1.6V	*	*
G.SKILL	F3-10666CL9T-6GBNQ	6144MB(Kit of 3)	DS	-	-	9-9-9-24	1.5V-1.6V	*	*
GEIL	DDR3-1333 CL9-9-9-24	1024MB	SS	-	-	9	-	*	*
GEIL	GV34GB1333C7DC	2048MB	DS	-	-	7-7-7-24	1.5V	*	*
GEIL	GG34GB1333C9DC	4096MB(Kit of 2)	DS	GEIL	GL1L128M88BA12N	9-9-9-24	1.3V(low voltage)	*	*
GEIL	DDR3-1333 CL9-9-9-24	6144MB(Kit of 3)	DS	-	-	9	1.5V	*	*
Kingmax	FLFD45F-B8MF9	1024MB	SS	Micron	8HD22D9JNM	-	-	*	*
Kingmax	FLFD45F-B8MH9 MAES	1024MB	SS	Micron	9CF22D9KPT	-	-	*	*
Kingmax	FLFE85F-B8MF9	2048MB	DS	Micron	8HD22D9JNM	-	-	*	*
Kingmax	FLFE85F-B8MH9 MEES	2048MB	DS	Micron	9GF27D9KPT	-	-	*	*
KINGSTON	KVR1333D3N9/2G	2048MB	DS	Qimonda	IDS1H1G-03A1F1C-13H	-	1.5V	*	*
Micron	MT8JTF12864AZ-1G4F1	1024MB	SS	Micron	9FF22D9KPT	9	-	*	*
Micron	MT18JTF25664AZ-1G4F1	2048MB	DS	Micron	9KF27D9KPT	9	-	*	*
OCZ	OCZ3P13332GK	2048MB(Kit of 2)	SS	-	-	7-7-7-20	1.8V	*	*
OCZ	OCZ3X1333L3GK(XMP)	3072MB(Kit of 3)	SS	-	-	-	1.6V	*	*
OCZ	OCZ3G13334GK	4096MB(Kit of 2)	DS	-	-	-	1.7V	*	*
OCZ	OCZ3G1333L4GK	4096MB(Kit of 2)	DS	-	-	9-9-9-20	1.65V(low voltage)	*	*

continued on the next page

DDR3-1333(O.C.) MHz capability

Vendor	Part No.	Size	SS/ DS	Chip Brand	Chip NO.	Timing	Voltage	DIMM socket support (Optional)	
								A*	B*
OCZ	OCZ3P13334GK	4096MB(Kit of 2)	DS	-	-	7-7-7-20	1.8V	*	*
OCZ	OCZ3P1333LV4GK	4096MB(Kit of 2)	DS	-	-	7-7-7-20	1.65V(low voltage)	*	*
OCZ	OCZ3P1333LV4GK	4096MB(Kit of 2)	DS	-	-	7-7-7-20	1.65V	*	*
OCZ	OCZ3RPX1333EB4GK	4096MB(Kit of 2)	DS	-	-	6-5-5-20	1.85V	*	*
OCZ	OCZ3X13334GK(XMP)	4096MB(Kit of 2)	DS	-	-	7-7-7-20	1.75V	*	*
OCZ	OCZ3G1333LV6GK	6144MB(Kit of 3)	DS	-	-	9-9-9-20	1.65V	*	*
OCZ	OCZ3P1333LV6GK	6144MB(Kit of 3)	DS	-	-	7-7-7-20	1.65V	*	*
OCZ	OCZ3X1333LV6GK(XMP)	6144MB(Kit of 3)	DS	-	-	8-8-8-20	1.60V	*	*
PSC	AL7F8G73D-DG1	1024MB	SS	PSC	A3P1GF3DGF928M9B05	-	-	*	*
PSC	AL8F8G73D-DG1	2048MB	DS	PSC	A3P1GF3DGF928M9B05	-	-	*	*
SAMSUNG	M378B2873DZ1-CH9	1024MB	SS	Samsung	K4B1G0846D-HCH9	-	-	*	*
SAMSUNG	M378B2873DZ1-CH9	1024MB	SS	SAMSUNG	SEC 846 HCH9 K4B1G0846D	-	-	*	*
SAMSUNG	M378B2873EH1-CH9	1024MB	SS	Samsung	SEC 913 HCH9 K4B1G0846E	-	-	*	*
SAMSUNG	M378B5673DZ1-CH9	2048MB	DS	Samsung	K4B1G0846D-HCH9	-	-	*	*
SAMSUNG	M378B5673EH1-CH9	2048MB	DS	Samsung	SEC 913 HCH9 K4B1G0846E	-	-	*	*
Super Talent	W1333X2GB8(XMP)	1024MB	SS	-	-	-	-	*	*
Transcend	TS128MLK64V3U	1024MB	SS	-	SEC 813HCH9 K4B1G0846D	-	-	*	*
Transcend	TS256MLK64V3U	2048MB	DS	Micron	9GF27D9KPT	-	-	*	*
Transcend	TS256MLK64V3U	2048MB	DS	-	SEC816HCH9K4B1G0846D	-	-	*	*
ASINT	SLY3128M8-EDJ	1024MB	SS	ASINT	DDRIII1208-DJ 0844	-	-	*	*
ASINT	SLY3128M8-EDJE	1024MB	SS	ELPIDA	J1108BASE-DJ-E	-	-	*	*
ASINT	SLY3128M8-EDJ	2048MB	DS	ASINT	DDRIII1208-DJ 0844	-	-	*	*
ASINT	SLZ3128M8-EDJE	2048MB	DS	ELPIDA	J1108BASE-DJ-E	-	-	*	*
BUFFALO	FSX1333D3G-K2G	1024MB	SS	-	-	7-7-7-20	-	*	*
BUFFALO	FSX1333D3G-2G	2048MB	DS	-	-	7-7-7-20	-	*	*
Century	PC3-10600 DDR3-1333 9-9-9	1024MB	SS	Micron	8FD22D9JNM	-	-	*	*
Century	PC3-10600 DDR3-1333 9-9-9	2048MB	DS	Micron	8DD22D9JNM	-	-	*	*
Elixir	M2Y2G64CB8HA9N-CG	2048MB	DS	-	-	7-7-7-20	-	*	*
Elixir	M2Y2G64CB8HC9N-CG	2048MB	DS	Elixir	-	-	-	*	*
Kingtiger	2GB DIMM PC3-10666	2048MB	DS	Samsung	SEC 904 HCH9 K4B1G0846D	-	-	*	*
Kingtiger	KTG2G1333PG3	2048MB	DS	-	-	-	-	*	*
PATRIOT	PSD31G13332H	1024MB	DS	-	-	9	-	*	*
PATRIOT	PSD31G13332	1024MB	DS	Patriot	PM64M8D38U-15	-	-	*	*
PATRIOT	PSD32G13332H	2048MB	DS	-	-	-	-	*	*
PATRIOT	PDC34G1333ELK	4096MB(Kit of 2)	DS	-	-	9-9-9-24	1.5V	*	*
SILICON POWER	SP001GBLTU133S01	1024MB	SS	NANYA	NT5CB128M8AN-CG	9	-	*	*
SILICON POWER	SP001GBLTU133S02	1024MB	SS	elixir	N2CB1680AN-C6	9	-	*	*
SILICON POWER	SP002GBLTU133S02	2048MB	DS	elixir	N2CB1680AN-C6	9	-	*	*
TAKEMS	TMS1GB364D081-107EY	1024MB	SS	-	-	7-7-7-20	1.5V	*	*
TAKEMS	TMS1GB364D081-138EY	1024MB	SS	-	-	8-8-8-24	1.5V	*	*
TAKEMS	TMS2GB364D081-107EY	2048MB	DS	-	-	7-7-7-20	1.5V	*	*
TAKEMS	TMS2GB364D081-138EY	2048MB	DS	-	-	8-8-8-24	1.5V	*	*
TAKEMS	TMS2GB364D082-138EW	2048MB	DS	-	-	8-8-8-24	1.5V	*	*

DDR2-667 MHz capability

Vendor	Part No.	Size	SS/DS	Chip Brand	Chip NO.	Timing	Voltage	DIMM socket support (Optional)	
								A*	B*
A-Data	M2OAD5H3J41701C53	2048MB	DS	A-Data	AD20908A8A-3EG 30724	-	-	*	*
G.SKILL	F2-5400PHU2-2GBNT	2048MB(Kit of 2)	DS	G.SKILL	D2 64M8CCF 0815 C7178S	5-5-5-15	-	*	*
G.SKILL	F2-5300CL5D-4GBMQ	4096MB(Kit of 2)	DS	G.SKILL	Heat-Sink Package SN:8151030036559	5-5-5-15	-	*	*
GEIL	GX21GB5300SX	1024MB	DS	GEIL	-	3	-	*	*
GEIL	GX22GB5300LX	2048MB	DS	GEIL	-	5	-	*	*
GEIL	GX24GB5300LDC	2048MB	DS	GEIL	-	5	-	*	*
KINGSTON	KVR667D2N5/1G(low profile)	1024MB	SS	Elpida	E1108AFSE-8E-F	5	1.8V	*	*
KINGSTON	KVR667D2N5/2G(low profile)	2048MB	DS	Elpida	E1108AFBG-8E-F	5	1.8V	*	*
PSC	AL7E8F73C-6E1	1024MB	SS	PSC	A3R1GE3CFF734MAA0J	5	-	*	*
PSC	AL6E8E63J-6E1	512MB	SS	PSC	A3R12E3JFF717B9A00	5	-	*	*
PSC	AL6E8E63J-6E1	1024MB	DS	PSC	A3R12E3JFF717B9A01	5	-	*	*
PSC	AL8E8F73C-6E1	2048MB	DS	PSC	A3R1GE3CFF733MAA00	5	-	*	*
SAMSUNG	M378T5263AZ3-CE6	4096MB	DS	Samsung	K4T2G084QA-HCE6	-	-	*	*
Transcend	JM667QLJ-1G	1024MB	DS	Elpida	E5108AJBG-6E-E	5	-	*	*
Transcend	JM667QLU-2G	2048MB	DS	Transced	TQ243PCF8T0834	5	-	*	*
Twinmos	8D-A3JK5MPETP	512MB	SS	PSC	A3R12E3GEF633ACA0Y	5	-	*	*

DDR2-800 MHz capability

Vendor	Part No.	Size	SS/DS	Chip Brand	Chip NO.	Timing	Voltage	DIMM socket support (Optional)	
								A*	B*
A-Data	AD2800E001GOU	2048MB(Kit of 2)	SS	-	-	4-4-4-12	2.0~2.1V	*	*
A-Data	M2GV6G314170Q1E58	1024MB	DS	V-Data	VD29608A8A-25EG80813	-	-	*	*
A-Data	AD2800002GMU	2048MB	DS	Hynix	-	-	-	*	*
A-Data	AD2800E002GOU	4096MB(Kit of 2)	DS	-	-	4-4-4-12	1.9~2.1V	*	*
Apacer	78.01GA0.9L5	1024MB	SS	APACER	AM4B5808FEWS8E	-	-	*	*
Apacer	78.A1GA0.9L4	2048MB	DS	APACER	AM4B5808FEWS8E	-	-	*	*
CORSAIR	XMS2-6400	1024MB	DS	Corsair	-	4	-	*	*
CORSAIR	XMS2-6400	1024MB	DS	Corsair	-	5	-	*	*
CORSAIR	CM2X2048-6400C5DHX	4096MB(Kit of 2)	DS	-	-	5	-	*	*
CORSAIR	CM2X2048-6400C5	4096MB(Kit of 2)	DS	-	-	5	-	*	*
Crucial	BL12864AL80A.8FE5(EPP)	2048MB(Kit of 2)	SS	-	-	4-4-4-12	-	*	*
Crucial	BL25664AL80A.16FE5(EPP)	4096MB(Kit of 2)	DS	-	-	4-4-4-12	-	*	*
Crucial	BL25664AR80A.16FE5(EPP)	4096MB(Kit of 2)	DS	-	-	4-4-4-12	-	*	*
G.SKILL	F2-6400PHU2-2GBNR	1024MB	SS	-	-	5-5-5-15	1.9-2.0V	*	*
G.SKILL	F2-6400CL5D-1GBNQ	512MB	SS	G.SKILL	Heat-Sink Package SN:8151030036642	5-5-5-15	-	*	*
G.SKILL	F2-6400CL4D-2GBPK	1024MB	DS	G.SKILL	-	4	-	*	*
G.SKILL	F2-6400CL5D-2GBNQ	1024MB	DS	G.SKILL	-	5	-	*	*
G.SKILL	F2-6400CL4D-4GBPK	2048MB	DS	G.SKILL	-	4	-	*	*
G.SKILL	F2-6400CL5D-4GBPQ	2048MB	DS	G.SKILL	-	5	-	*	*
G.SKILL	F2-6400CL6D-4GBMQ	4096MB(Kit of 2)	DS	-	-	6-6-6-18	1.8-1.9V	*	*
G.SKILL	F2-6400CL6Q-16GMQ	4096MB	DS	-	-	5	-	*	*
GEIL	GB22GB6400C4DC	1024MB	DS	GEIL	GL2L64M088BA30EB	5	-	*	*
GEIL	GB22GB6400C5DC	1024MB	DS	GEIL	GL2L64M088BA30EB	5	-	*	*
GEIL	GB24GB6400C4QC	1024MB	DS	GEIL	GL2L64M088BA30EB	4	-	*	*
GEIL	GB24GB6400C5QC	1024MB	DS	GEIL	GL2L64M088BA30EB	5	-	*	*
GEIL	GE22GB800C4DC	1024MB	DS	GEIL	-	4	-	*	*
GEIL	GE22GB800C5DC	1024MB	DS	GEIL	-	5	-	*	*
GEIL	GE24GB800C4QC	1024MB	DS	GEIL	-	4	-	*	*

continued on the next page

DDR2-800 MHz capability

Vendor	Part No.	Size	SS/DS	Chip Brand	Chip NO.	Timing	Voltage	DIMM socket support (Optional)	
								A'	B'
GEIL	GE24GB800C5QC	1024MB	DS	GEIL	-	5	-	*	*
GEIL	GX22GB6400DC	1024MB	DS	GEIL	-	5	1.8V	*	*
GEIL	GX22GB6400UDC	1024MB	DS	GEIL	-	4	-	*	*
GEIL	GB24GB6400C4DC	2048MB	DS	GEIL	-	5	-	*	*
GEIL	GB24GB6400C5DC	2048MB	DS	GEIL	GL2L128M88BA25AB	5	-	*	*
GEIL	GB28GB6400C4QC	2048MB	DS	GEIL	GL2L128M88BA25AB	4	-	*	*
GEIL	GB28GB6400C5QC	2048MB	DS	GEIL	GL2L128M88BA25AB	5	-	*	*
GEIL	GE24GB800C4DC	2048MB	DS	GEIL	-	4	-	*	*
GEIL	GE24GB800C5DC	2048MB	DS	GEIL	-	5	-	*	*
GEIL	GE28GB800C4QC	2048MB	DS	GEIL	-	4	-	*	*
GEIL	GE28GB800C5QC	2048MB	DS	GEIL	-	5	-	*	*
GEIL	GX22GB6400C4USC	2048MB	DS	GEIL	-	4	-	*	*
GEIL	GX22GB6400LX	2048MB	DS	GEIL	-	5	-	*	*
GEIL	GX24GB6400DC	2048MB	DS	GEIL	-	5	-	*	*
Kingmax	KLD48F-B8KU5 NGES	1024MB	SS	Kingmax	KKB8FNUBF-DNX-25A	-	-	*	*
Kingmax	KLDE88F-B8KU5 NHES	2048MB	DS	Kingmax	KKB8FNUBF-DNX-25A	-	-	*	*
KINGSTON	KVR800D2N5/1G(low profile)	1024MB	SS	Elpida	E1108AFSE-8E-F	5	1.8V	*	*
KINGSTON	KVR800D2N5/1G(low profile)	1024MB	SS	Elpida	E1108AFBG-8E-F	6	1.8V	*	*
KINGSTON	KHX6400D2K2/2G	2048MB(Kit of 2)	DS	-	-	5-5-5-15	2.0V	*	*
KINGSTON	KVR800D2N5/2G(low profile)	2048MB	DS	Kingston	D1288TEFCGL25U	5	1.8V	*	*
KINGSTON	KVR800D2N6/2G(low profile)	2048MB	DS	Samsung	K4T1G084QE	6	1.8V	*	*
KINGSTON	KVR800D2N6/4G	4096MB	DS	Elpida	E2108ABSE-8G-E	6	1.8V	*	*
OCZ	OC22G800R22GK	1024MB	DS	OCZ	-	4-5-5-15	2.0V	*	*
OCZ	OC22P800R22GK	1024MB	DS	OCZ	-	4-4-4-15	1.9 - 2.1V	*	*
OCZ	OC22RPP8002GK	1024MB	DS	OCZ	-	4-4-4-15	2.1V	*	*
OCZ	OC22VU8004GK	1024MB	DS	OCZ	-	5-6-6-18	1.8V	*	*
OCZ	OC22SE8002GK	2048MB(Kit of 2)	DS	-	-	5-5-5-15	1.5V	*	*
OCZ	OC22F8004GK(EPP)	2048MB	DS	-	-	5-4-4-18	2.1V	*	*
OCZ	OC22P8004GK	4096MB(Kit of 2)	DS	-	-	5-4-4-15	2.1v	*	*
OCZ	OC22VU8004GK	4096MB(Kit of 2)	DS	-	-	5-6-6-18	1.8V	*	*
PSC	AL7E8F73C-8E1	1024MB	SS	PSC	A3R1GE3CF734MAA0E	5	-	*	*
PSC	AL7E8G73F-8E1	1024MB	SS	PSC	P3R1GE3FGF850MAC19	-	-	*	*
PSC	AL8E8F73C-8E1	2048MB	DS	PSC	A3R1GE3CF734MAA0E	5	-	*	*
PSC	AL8E8G73F-8E1	2048MB	DS	PSC	P3R1GE3FGF850MAC19	-	-	*	*
PSC	PL8E8F73C-8E1	2048MB	DS	PSC	SHG772-AA3G	5	-	*	*
PSC	PL8E8G73E-8E1	2048MB	DS	PSC	XCP271A3G-A	5	-	*	*
SAMSUNG	M378T2863EHS-CF7	1024MB	SS	Samsung	K4T1G084QE	-	-	*	*
SAMSUNG	M378T2863QZS-CF7	1024MB	SS	Qimonda	K4T1G084QQ-HCF7	6	-	*	*
SAMSUNG	M378T6553GZS-CF7	512MB	SS	Qimonda	K4T51083QG-HCF7	6	-	*	*
SAMSUNG	M378T2953GZ3-CF7	1024MB	DS	Samsung	K4T51083QG	-	-	*	*
SAMSUNG	M378T2953GZ3-CF7	1024MB	DS	Samsung	K4T51083QG-HCF7	6	-	*	*
SAMSUNG	M378T5663QZ3-CF7	2048MB	DS	Samsung	K4T1G084QQ-HCF7	6	-	*	*
SAMSUNG	M378T5263AZ3-CF7	4096MB	DS	Samsung	K4T2G084QA-HCF7	-	-	*	*
Super Talent	T800U1GC4	1024MB	DS	Super Talent	-	4	1.8V	*	*
Transcend	TS128MLQ64V8J	1024MB	SS	ELPIDA	E1108ACBG-8E-E	5	-	*	*
Transcend	TS64MLQ64V8J	512MB	SS	Micron	7HD22 D9GMH	5	-	*	*
Transcend	JM800QLJ-1G	1024MB	DS	Transcend	TQ123PJF8F0801	5	-	*	*
Transcend	JM800QLJ-1G	1024MB	DS	Transcend	TQ123YBF8 T0747	5	-	*	*
Transcend	TS128MLQ64V8J	1024MB	DS	Mircon	7HD22D9GMH	5	-	*	*
Transcend	JM800QLU-2G	2048MB	DS	Transcend	TQ243PCF8	5	-	*	*
Transcend	TS256MLQ64V8U	2048MB	DS	Elpida	E1108ACBG-8E-E	5	-	*	*
V-Data	M2GVD6G3H3160Q1E52	512MB	SS	V-Data	VD29608A8A-25EG20813	-	-	*	*
V-Data	M2XSSKG3147C1L1C5Z	1024MB	DS	Samsung	K4T51083QE	-	-	*	*
V-Data	M2XHYKH3J47CC01E5Z	2048MB	DS	Hynix	H5PS1G83EFRS6C852AK	-	-	*	*

DDR2-1066 (O.C.) MHz capability

Vendor	Part No.	Size	SS/ DS	Chip Brand	Chip NO.	Timing	Voltage	DIMM socket support (Optional)	
								A*	B*
A-Data	AD21066E001GOU	1024MB	SS	-	Heat-Sink Package	5-5-5-15	-	•	•
A-data	AD21066E002GOU	2048MB	DS	-	-	5-5-5-15	2.1V-2.3V	•	•
CORSAIR	TWIN2X4096-8500C5D G	4096MB(kit of 2)	DS	-	-	5-5-5-15	2.10V	•	•
CORSAIR	TWIN2X4096-8500C7 G	4096MB(kit of 2)	DS	-	-	7-7-7-20	2.00V	•	•
Crucial	BL12864AA1065.8FE5	1024MB	SS	-	-	-	-	•	•
G.SKILL	F2-8500CL5S-1GBPK	1024MB	DS	-	-	5-5-5-15	-	•	•
G.SKILL	F2-8500CL5D-2GBPK	2048MB(kit of 2)	DS	-	-	5-5-5-15	-	•	•
G.SKILL	F2-8500CL5D-4GBPI-B	4096MB(kit of 2)	DS	-	-	5-5-5-15	2.0-2.1V	•	•
G.SKILL	F2-8500CL5D-4GBPK	4096MB(kit of 2)	DS	-	-	5-5-5-15	-	•	•
GEIL	GB22GB8500C5DC	1024MB	SS	GEIL	GL2L128M88BA18BW	5	-	•	•
GEIL	GB24GB8500C5QC	1024MB	SS	GEIL	GL2L128M88BA25AB	5	-	•	•
GEIL	GE22GB1066C5DC	1024MB	SS	GEIL	-	5	-	•	•
GEIL	GE24GB1066C5OC	1024MB	SS	GEIL	-	5	-	•	•
GEIL	GB24GB8500C5DC	2048MB	DS	GEIL	GL2L128M88BA25AB	5	-	•	•
GEIL	GE24GB1066C5DC	2048MB	DS	GEIL	-	5	-	•	•
GEIL	GX24GB8500C5UDC	4096MB(kit of 2)	DS	-	-	5	-	•	•
Kingmax	KLED48F-B8KU6-NGES	1024MB	SS	Kingmax	KKB8FNUXF-DXX-18A	6-6-6-24	1.9V	•	•
Kingmax	KLEE88F-B8KU6-NNAS	2048MB	DS	Kingmax	KKB8FNUXF-DXX-18A	6-6-6-24	1.9V	•	•
KINGSTON	KHX8500D2/1G	1024MB	SS	-	Heat-Sink Package	-	-	•	•
KINGSTON	KHX8500D2K2/2G	1024MB	DS	-	-	-	2.2V	•	•
KINGSTON	KHX8500D2K2/4G	2048MB	DS	-	-	5-5-5-15	2.2V	•	•
OCZ	OCZ2N10662GK(EPP)	2048MB(kit of 2)	DS	-	-	5-5-5-15	21.V	•	•
OCZ	OCZ2F10664GK	4096MB(kit of 2)	DS	-	-	6-7-7-20	2.2V	•	•
OCZ	OCZ2P10664GK	4096MB(kit of 2)	DS	-	-	-	2.2V	•	•
PSC	AL8E8G73F-AE1	2048MB	DS	PSC	A3R1GE3FGF907MATOFTAIWAN-G8E	5-5-5-12	-	•	•
Transcend	TX1066QLU-2GK	2048MB(kit of 2)	SS	-	-	5	-	•	•
Transcend	TX1066QLU-4GK	4096MB(kit of 2)	DS	Transcend	-	5	-	•	•



SS - Single-sided / DS - Double - sided

DIMM support:

- **A***: Supports one module inserted into any slot as Single-channel memory configuration.
- **B***: Supports one pair of DDR2 modules inserted into both the blue slots or one pair of DDR3 modules into both the black slots as one pair of Dual-channel memory configuration.



Visit the ASUS website at www.asus.com for the latest QVL.

1.7.3 Installing a DIMM



Unplug the power supply before adding or removing DIMMs or other system components. Failure to do so can cause severe damage to both the motherboard and the components.

To install a DIMM:

1. Press the retaining clips outward to unlock a DIMM socket.
2. Align a DIMM on the socket such that the notch on the DIMM matches the DIMM slot key on the socket.

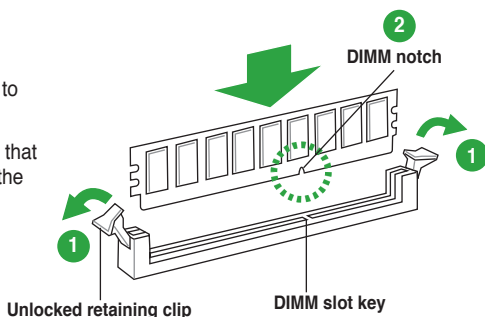

A DIMM is keyed with a notch so that it fits in only one direction. DO NOT force a DIMM into a socket in the wrong direction to avoid damaging the DIMM.

3. Firmly insert the DIMM into the socket until the retaining clips snap back in place and the DIMM is properly seated.

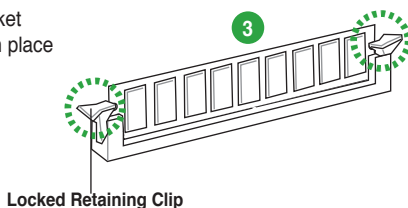

1.7.4 Removing a DIMM

To remove a DIMM:

1. Simultaneously press the retaining clips outward to unlock the DIMM.



Support the DIMM lightly with your fingers when pressing the retaining clips. The DIMM might get damaged when it flips out with extra force.

2. Remove the DIMM from the socket.

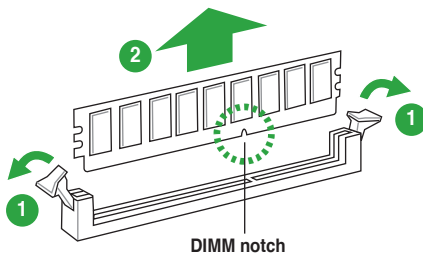

1.8 Expansion slots

In the future, you may need to install expansion cards. The following sub-sections describe the slots and the expansion cards that they support.



Unplug the power cord before adding or removing expansion cards. Failure to do so may cause you physical injury and damage motherboard components.

1.8.1 Installing an expansion card

To install an expansion card:

1. Before installing the expansion card, read the documentation that came with it and make the necessary hardware settings for the card.
2. Remove the system unit cover (if your motherboard is already installed in a chassis).
3. Remove the bracket opposite the slot that you intend to use. Keep the screw for later use.
4. Align the card connector with the slot and press firmly until the card is completely seated on the slot.
5. Secure the card to the chassis with the screw you removed earlier.
6. Replace the system cover.

1.8.2 Configuring an expansion card

After installing the expansion card, configure it by adjusting the software settings.

1. Turn on the system and change the necessary BIOS settings, if any. See Chapter 2 for information on BIOS setup.
2. Assign an IRQ to the card.
3. Install the software drivers for the expansion card.



When using PCI cards on shared slots, ensure that the drivers support "Share IRQ" or that the cards do not need IRQ assignments. Otherwise, conflicts will arise between the two PCI groups, making the system unstable and the card inoperable.

1.8.3 PCI slots

The PCI slots support cards such as a LAN card, SCSI card, USB card, and other cards that comply with PCI specifications.

1.8.4 PCI Express x1 slot

This motherboard supports PCI Express x1 network cards, SCSI cards, and other cards that comply with the PCI Express specifications.

1.8.5 PCI Express x16 slot

This motherboard supports a PCI Express x16 graphics card that complies with the PCI Express specifications.

1.9 Jumpers

1. Clear RTC RAM (3-pin CLRRTC)

This jumper allows you to clear the Real Time Clock (RTC) RAM in CMOS. You can clear the CMOS memory of date, time, and system setup parameters by erasing the CMOS RTC RAM data. The onboard button cell battery powers the RAM data in CMOS, which include system setup information such as system passwords.

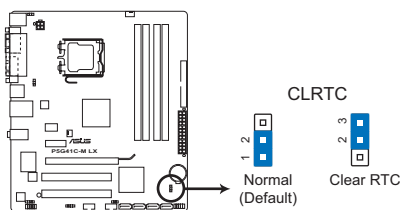

P5G41C-M LX Clear RTC RAM

To erase the RTC RAM:

1. Turn OFF the computer and unplug the power cord.
2. Move the jumper cap from pins 1-2 (default) to pins 2-3. Keep the cap on pins 2-3 for about 5-10 seconds, then move the cap back to pins 1-2.
3. Plug the power cord and turn ON the computer.
4. Hold down the **** key during the boot process and enter BIOS setup to re-enter data.



Except when clearing the RTC RAM, never remove the cap on CLRRTC jumper default position. Removing the cap will cause system boot failure!



- If the steps above do not help, remove the onboard battery and move the jumper again to clear the CMOS RTC RAM data. After clearing the CMOS, reinstall the battery.
 - You do not need to clear the RTC when the system hangs due to overclocking. For system failure due to overclocking, use the CPU Parameter Recall (C.P.R.) feature. Shut down and reboot the system, then the BIOS automatically resets parameter settings to default values.
-

2. Keyboard power (3-pin KBPWR)

This jumper allows you to enable or disable the keyboard wake-up feature. When you set this jumper to pins 2–3 (+5VSB), you can wake up the computer by pressing a key on the keyboard. This feature requires an ATX power supply that can supply at least 1A on the +5VSB lead, and a corresponding setting in the BIOS.

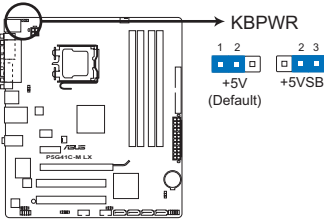

P5G41C-M LX Keyboard Power Setting

3. USB device wake-up (3-pin USBPW1-4, 3-pin USBPW5-8)

Set these jumpers to +5V to wake up the computer from S1 sleep mode (CPU stopped, DRAM refreshed, system running in low power mode) using the connected USB devices. Set to +5VSB to wake up from S3 and S4 sleep modes (no power to CPU, DRAM in slow refresh, power supply in reduced power mode).

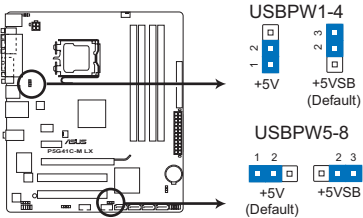

P5G41C-M LX USB Device Wake Up



- The USB device wake-up feature requires a power supply that can provide 500mA on the +5VSB lead for each USB port; otherwise, the system would not power up.
- The total current consumed must NOT exceed the power supply capability (+5VSB) whether under normal condition or in sleep mode.

1.10 Connectors

1.10.1 Rear panel connectors

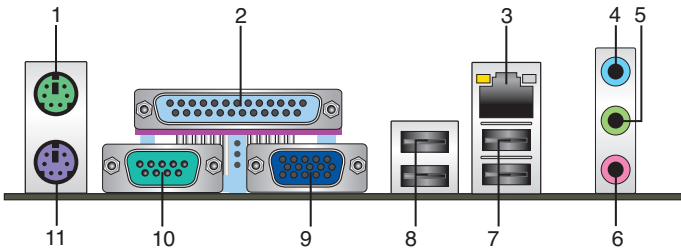

- PS/2 mouse port (green).** This port is for a PS/2 mouse.
- Parallel port.** This 25-pin port connects a parallel printer, a scanner, or other devices.
- LAN (RJ-45) port.** This port allows Gigabit connection to a Local Area Network (LAN) through a network hub. Refer to the table below for the LAN port LED indications.

LAN port LED indications

ACT/LINK LED		SPEED LED	
Status	Description	Status	Description
OFF	No link	OFF	10 Mbps connection
ORANGE	Linked	ORANGE	100 Mbps connection
BLINKING	Data activity	GREEN	1 Gbps connection

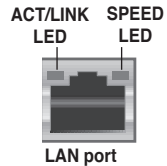

- Line In port (light blue).** This port connects to the tape, CD, DVD player, or other audio sources.
- Line Out port (lime).** This port connects to a headphone or a speaker. In the 4, 6, and 8-channel configurations, the function of this port becomes Front Speaker Out.
- Microphone port (pink).** This port connects to a microphone.



Refer to the audio configuration table below for the function of the audio ports in a 2, 4, 6, or 8-channel configuration.

Audio 2, 4, 6, or 8-channel configuration

Port	Headset 2-channel	4-channel	6-channel	8-channel
Light Blue (Rear panel)	Line In	Rear Speaker Out	Rear Speaker Out	Rear Speaker Out
Lime (Rear panel)	Line Out	Front Speaker Out	Front Speaker Out	Front Speaker Out
Pink (Rear panel)	Mic In	Mic In	Bass/Center	Bass/Center
Lime (Front panel)	-	-	-	Side Speaker Out



To configure an 8-channel audio output:

Use the chassis with HD audio module in the front panel to support 8-channel audio output.

7. **USB 2.0 ports 1 and 2.** These two 4-pin Universal Serial Bus (USB) ports are available for connecting USB 2.0 devices.
8. **USB 2.0 ports 3 and 4.** These two 4-pin Universal Serial Bus (USB) ports are available for connecting USB 2.0 devices.
9. **VGA port.** This 15-pin port is for a VGA monitor or other VGA-compatible devices.
10. **COM port.** This port is for pointing devices or other serial devices.
11. **PS/2 Keyboard port (purple).** This port is for a PS/2 keyboard.

1.10.2 Internal connectors

1. Front panel audio connector (10-1 pin AAFP)

This connector is for a chassis-mounted front panel audio I/O module that supports either HD Audio or legacy AC'97 audio standard. Connect one end of the front panel audio I/O module cable to this connector.

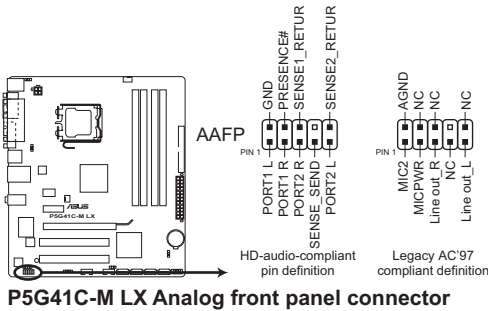

- We recommend that you connect a high-definition front panel audio module to this connector to avail of the motherboard's high-definition audio capability.
- If you want to connect a high-definition front panel audio module to this connector, set the **Front Panel Type** item in the BIOS setup to **[HD Audio]**. If you want to connect an AC'97 front panel audio module to this connector, set the item to **[AC97]**. By default, this connector is set to **[HD Audio]**. See section 2.4.3 Chipset for details.

2. IDE connector (40-1 pin PRI_IDE)

The onboard IDE connector is for the Ultra DMA 100/66/33 signal cable. There are three connectors on each Ultra DMA 100/66/33 signal cable: blue, black, and gray. Connect the blue connector to the motherboard's IDE connector, then select one of the following modes to configure your device.

	Drive jumper setting	Mode of device(s)	Cable connector
Single device	Cable-Select or Master	-	Black
Two devices	Cable-Select	Master	Black
		Slave	Gray
	Master	Master	Black or gray
	Slave	Slave	



- Pin 20 on the IDE connector is removed to match the covered hole on the Ultra DMA cable connector. This prevents incorrect insertion when you connect the IDE cable.
- Use the 80-conductor IDE cable for Ultra DMA 100/66/33 IDE devices.

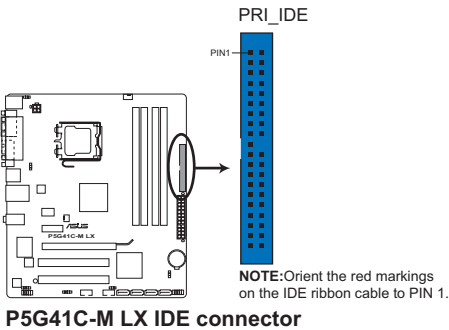

- If any device jumper is set as "Cable-Select," ensure that all other device jumpers have the same setting.

3. ATX power connectors (24-pin EATXPWR, 4-pin ATX12V)

These connectors are for ATX power supply plugs. The power supply plugs are designed to fit these connectors in only one orientation. Find the proper orientation and push down firmly until the connectors completely fit.

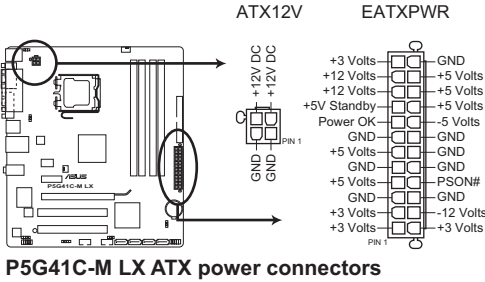

- We recommend that you use an ATX 12V Specification 2.0-compliant power supply unit (PSU) with a minimum of 400W power rating. This PSU type has 24-pin and 4-pin power plugs.
- If you intend to use a PSU with 20-pin and 4-pin power plugs, ensure that the 20-pin power plug can provide at least 15 A on +12 V and that the PSU has a minimum power rating of 400W. The system may become unstable or may not boot up if the power is inadequate.
- DO NOT forget to connect the 4-pin ATX +12V power plug. Otherwise, the system will not boot up.
- We recommend that you use a PSU with higher power output when configuring a system with more power-consuming devices or when you intend to install additional devices. The system may become unstable or may not boot up if the power is inadequate.
- If you are uncertain about the minimum power supply requirement for your system, refer to the Recommended Power Supply Wattage Calculator at <http://support.asus.com/PowerSupplyCalculator/PSCalculator.aspx?SLanguage=en-us> for details.

4. Serial ATA connectors (7-pin SATA1-4)

These connectors are for the Serial ATA signal cables for Serial ATA 3Gb/s hard disk and optical disk drives. The Serial ATA 3Gb/s is backward compatible with Serial ATA 1.5Gb/s specification. The data transfer rate of the Serial ATA 3Gb/s is faster than the standard parallel ATA with 133 MB/s (Ultra DMA133).

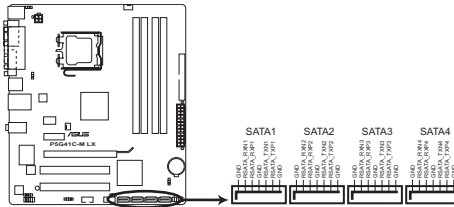

P5G41C-M LX SATA connectors



Install the Windows® XP Service Pack 2 or later version before using Serial ATA.

5. USB connectors (10-1 pin USB56, USB78)

These connectors are for USB 2.0 ports. Connect the USB module cable to any of these connectors, then install the module to a slot opening at the back of the system chassis. These USB connectors comply with USB 2.0 specification that supports up to 480 Mbps connection speed.

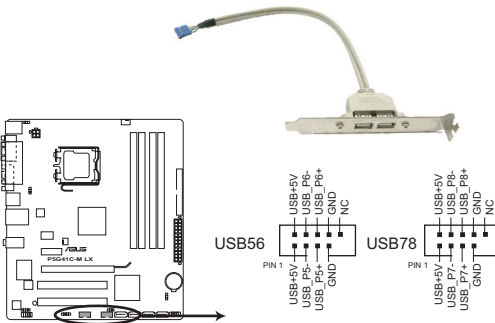

P5G41C-M LX USB2.0 connectors



Never connect a 1394 cable to the USB connectors. Doing so will damage the motherboard!



The USB module cable is purchased separately.

6. CPU and chassis fan connectors (4-pin CPU_FAN, 3-pin CHA_FAN)

Connect the fan cables to the fan connectors on the motherboard, ensuring that the black wire of each cable matches the ground pin of the connector.



Do not forget to connect the fan cables to the fan connectors. Insufficient air flow inside the system may damage the motherboard components. These are not jumpers! Do not place jumper caps on the fan connectors!

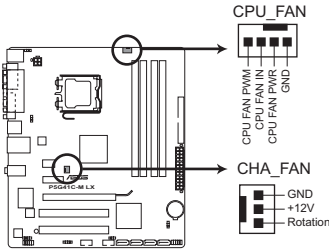

P5G41C-M LX fan connectors



Only the 4-pin CPU fan supports the ASUS Q-FAN feature.

7. Digital audio connector (4-1 pin SPDIF_OUT)

This connector is for an additional Sony/Philips Digital Interface (S/PDIF) port. Connect the S/PDIF Out module cable to this connector, then install the module to a slot opening at the back of the system chassis.

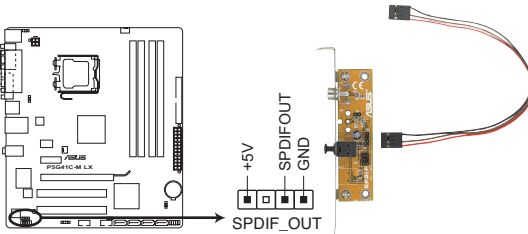

P5G41C-M LX Digital audio connector



The S/PDIF module is purchased separately.

8. System panel connector (10-1 pin F_PANEL)

This connector supports several chassis-mounted functions.

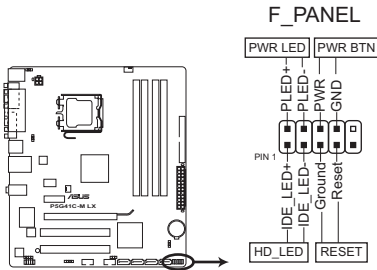

P5G41C-M LX System panel connector

- **System power LED (2-pin PLED)**

This 2-pin connector is for the system power LED. Connect the chassis power LED cable to this connector. The system power LED lights up when you turn on the system power, and blinks when the system is in sleep mode.

- **Hard disk drive activity LED (2-pin +HDLED)**

This 2-pin connector is for the HDD Activity LED. Connect the HDD Activity LED cable to this connector. The HD LED lights up or flashes when data is read from or written to the HDD.

- **ATX power button/soft-off button (2-pin PWRBTN)**

This 2-pin connector is for the system power button.

- **Reset button (2-pin RESET)**

This 2-pin connector is for the chassis-mounted reset button for system reboot without turning off the system power.

9. Speaker connector (4-pin SPEAKER)

This 4-pin connector is for the chassis-mounted system warning speaker. The speaker allows you to hear system beeps and warnings.

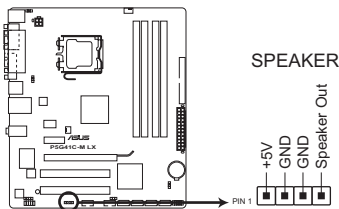

P5G41C-M LX Speaker Out Connector

1.11 Software support

1.11.1 Installing an operating system

This motherboard supports Windows® XP/Vista/7 Operating Systems (OS). Always install the latest OS version and corresponding updates to maximize the features of your hardware.



- Motherboard settings and hardware options vary. Refer to your OS documentation for detailed information.
- Ensure that you install Windows® XP Service Pack 3 or later version / Windows® Vista Service Pack 1 or later version before installing the drivers for better compatibility and system stability.

1.11.2 Support DVD information

The Support DVD that comes with the motherboard package contains the drivers, software applications, and utilities that you can install to avail all motherboard features.



The contents of the Support DVD are subject to change at any time without notice. Visit the ASUS website at www.asus.com for updates.

To run the Support DVD

Place the Support DVD to the optical drive. The DVD automatically displays the Drivers menu if Autorun is enabled in your computer.



The following screen is for reference only.

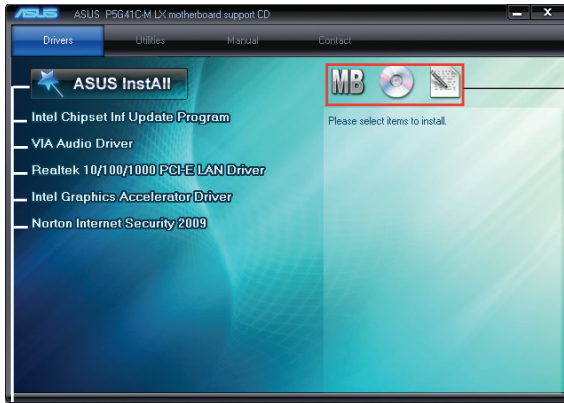

Click an icon to display Support DVD/ motherboard information

Click an item to install



If Autorun is NOT enabled in your computer, browse the contents of the Support DVD to locate the file ASSETUP.EXE from the BIN folder. Double-click the ASSETUP.EXE to run the DVD.

Chapter 2

BIOS information

2.1 Managing and updating your BIOS



Save a copy of the original motherboard BIOS file to a USB flash disk in case you need to restore the BIOS in the future. Copy the original motherboard BIOS using the ASUS Update utility.

2.1.1 ASUS Update utility

The ASUS Update is a utility that allows you to manage, save, and update the motherboard BIOS in Windows® environment.



-
- ASUS Update requires an Internet connection either through a network or an Internet Service Provider (ISP).
 - This utility is available in the support DVD that comes with the motherboard package.
-

Installing ASUS Update

To install ASUS Update:

1. Place the support DVD in the optical drive. The **Drivers** menu appears.
2. Click the **Utilities** tab, then click **ASUS Update**.
3. Follow the onscreen instructions to complete the installation.



Quit all Windows® applications before you update the BIOS using this utility.

Updating the BIOS

To update the BIOS:

1. From the Windows® desktop, click **Start > Programs > ASUS > ASUSUpdate > ASUSUpdate** to launch the ASUS Update utility.
2. From the dropdown list, select any of the updating process:
Updating from the Internet
 - a. Select **Update BIOS from the Internet**, then click **Next**.
 - b. Select the ASUS FTP site nearest you to avoid network traffic, or click **Auto Select** then click **Next**.
 - c. From the FTP site, select the BIOS version that you wish to download then click **Next**.



The ASUS Update utility is capable of updating itself through the Internet. Always update the utility to avail all its features.

Updating from a BIOS file

- a. Select **Update BIOS from a file**, then click **Next**.
 - b. Locate the BIOS file from the **Open** window, then click **Open**.
3. Follow the onscreen instructions to complete the updating process.

2.1.2 ASUS EZ Flash 2

The ASUS EZ Flash 2 feature allows you to update the BIOS without using an OS-based utility.



Before you start using this utility, download the latest BIOS file from the ASUS website at www.asus.com.

To update the BIOS using EZ Flash 2:

1. Insert the USB flash disk that contains the latest BIOS file to the USB port, then launch EZ Flash 2 in any of these two ways:
 - Press **<Alt> + <F2>** during POST.
 - Enter the BIOS setup program. Go to the **Tools** menu to select **EZ Flash 2** and press **<Enter>** to enable it.Press **<Tab>** to switch between drives until the correct BIOS file is found.

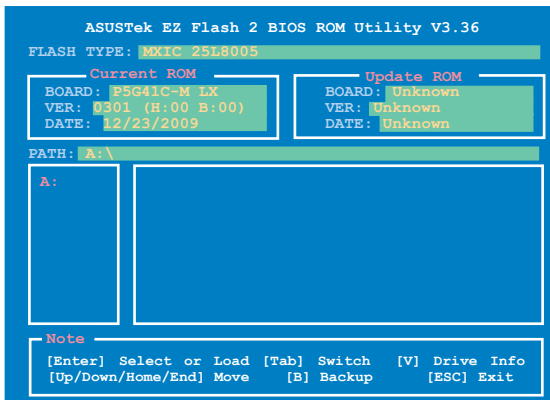

2. When the correct BIOS file is found, EZ Flash 2 performs the BIOS update process and automatically reboots the system when done.



- This function supports USB flash disks with **FAT 32/16** format and single partition only.
- **DO NOT** shut down or reset the system while updating the BIOS to prevent system boot failure!

2.1.3 ASUS CrashFree BIOS

The ASUS CrashFree BIOS is an auto recovery tool that allows you to restore the BIOS file when it fails or gets corrupted during the updating process. You can restore a corrupted BIOS file using the motherboard support DVD or a removable device that contains the updated BIOS file.



-
- Before using this utility, rename the BIOS file in the removable device into **P5G41CM.ROM**.
 - The BIOS file in the support DVD may not be the latest version. Download the latest BIOS file from the ASUS website at www.asus.com.
 - The removable devices that ASUS CrashFree BIOS support vary with motherboard models. For motherboards without the floppy connector, prepare a USB flash disk before using this utility.
-

Recovering the BIOS

To recover the BIOS:

1. Turn on the system.
2. Insert the support DVD to the optical drive or the removable device that contains the BIOS file to the USB port or to the floppy disk drive, if supported.
3. The utility automatically checks the devices for the BIOS file. When found, the utility reads the BIOS file and starts flashing the corrupted BIOS file.
4. Turn off the system after the utility completes the updating process and turn on again.



DO NOT shut down or reset the system while updating the BIOS! Doing so can cause system boot failure!



Ensure to load the BIOS default settings to ensure system compatibility and stability. Select the **Load Setup Defaults** item under the Exit menu. Refer to section **2.8 Exit menu** for details.

2.2 BIOS setup program

Use the BIOS Setup program to update the BIOS or configure its parameters. The BIOS screens include navigation keys and brief online help to guide you in using the BIOS Setup program.

Entering BIOS Setup at startup

To enter BIOS Setup at startup:

- Press <Delete> during the Power-On Self Test (POST). If you do not press <Delete>, POST continues with its routines.

Entering BIOS Setup after POST

To enter BIOS Setup after POST:

- Press <Ctrl>+<Alt>+ simultaneously.
- Press the reset button on the system chassis.
- Press the power button to turn the system off then back on. Do this option only if you failed to enter BIOS Setup using the first two options.



Using the **power button**, **reset button**, or the <Ctrl>+<Alt>+ keys to force reset from a running operating system can cause damage to your data or system. We recommend to always shut down the system properly from the operating system.



- The default BIOS settings for this motherboard apply for most conditions to ensure optimum performance. If the system becomes unstable after changing any BIOS settings, load the default settings to ensure system compatibility and stability. Select the **Load Setups Default** item under the Exit Menu. See section **2.8 Exit Menu**.
 - The BIOS setup screens shown in this section are for reference purposes only, and may not exactly match what you see on your screen.
 - Visit the ASUS website at www.asus.com to download the latest BIOS file for this motherboard.
-

2.2.1 BIOS menu screen

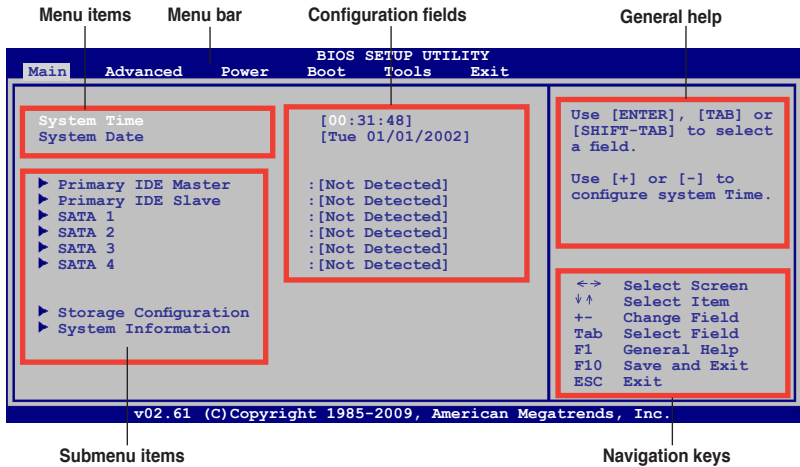

2.2.2 Menu bar

The menu bar on top of the screen has the following main items:

- Main** For changing the basic system configuration.
- Advanced** For changing the advanced system settings.
- Power** For changing the advanced power management (APM) configuration.
- Boot** For changing the system boot configuration.
- Tools** For configuring options for special functions.
- Exit** For selecting the exit options and loading default settings.

To select an item on the menu bar, press the right or left arrow key on the keyboard until the desired item is highlighted.

2.2.3 Navigation keys

At the bottom right corner of a menu screen are the navigation keys for that particular menu. Use the navigation keys to select items in the menu and change the settings.



Some of the navigation keys differ from one screen to another.

2.2.4 Menu items

The highlighted item on the menu bar displays the specific items for that menu. For example, selecting Main shows the Main menu items.

The other items (Advanced, Power, Boot, Tools, and Exit) on the menu bar have their respective menu items.

2.2.5 Submenu items

A solid triangle before each item on any menu screen means that the item has a submenu. To display the submenu, select the item and press **<Enter>**.

2.2.6 Configuration fields

These fields show the values for the menu items. If an item is user-configurable, you can change the value of the field opposite the item. You cannot select an item that is not user-configurable. A configurable field is enclosed in brackets, and is highlighted when selected. To change the value of a field, select it then press **<Enter>** to display a list of options. Refer to 2.2.7 Pop-up window.

2.2.7 Pop-up window

Select a menu item then press **<Enter>** to display a pop-up window with the configuration options for that item.

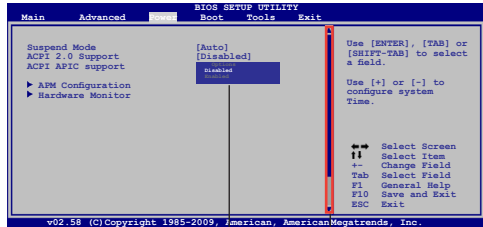

Pop-up window

Scroll bar

2.2.8 Scroll bar

A scroll bar appears on the right side of a menu screen when there are items that do not fit on the screen. Press the **<Up>** / **<Down>** arrow keys or **<Page Up>** / **<Page Down>** keys to display the other items on the screen.

2.2.9 General help

At the top right corner of the menu screen is a brief description of the selected item.

2.3 Main menu

When you enter the BIOS Setup program, the **Main** menu screen appears, giving you an overview of the basic system information.



Refer to section **2.2.1 BIOS menu screen** for information on the menu screen items and how to navigate through them.

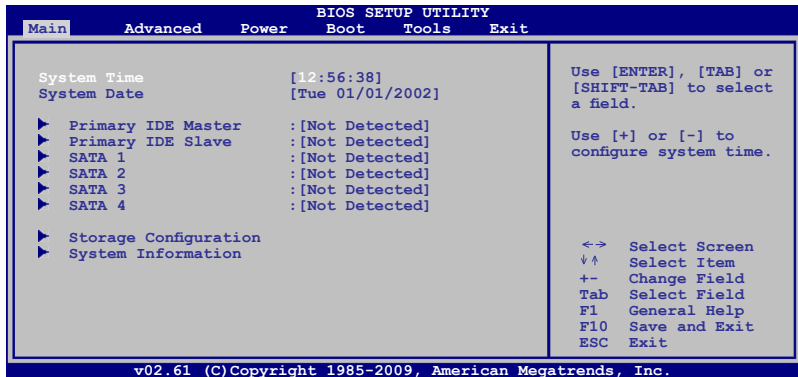

2.3.1 System Time [xx:xx:xx]

Allows you to set the system time.

2.3.2 System Date [Day xx/xx/xxxx]

Allows you to set the system date.

2.3.3 Primary IDE Master/Slave, SATA1~4

While entering Setup, the BIOS automatically detects the presence of IDE/SATA devices. There is a separate sub-menu for each IDE/SATA device. Select a device item then press <Enter> to display the IDE/SATA device information.

The BIOS automatically detects the values opposite the dimmed items (Device, Vendor, Size, LBA Mode, Block Mode, PIO Mode, Async DMA, Ultra DMA, and SMART monitoring). These values are not user-configurable. These items show Not Detected if no IDE/SATA device is installed in the system.

Type [Auto]

Selects the type of IDE drive. Setting to Auto allows automatic selection of the appropriate IDE device type. Select CDROM if you are specifically configuring a CD-ROM drive. Select ARMD (ATAPI Removable Media Device) if your device is either a ZIP, LS-120, or MO drive. Configuration options: [Not Installed] [Auto] [CDROM] [ARMD]



This item does not appear when you select the **SATA 1/2/3/4** devices.

LBA/Large Mode [Auto]

Enables or disables the LBA mode. Setting to **[Auto]** enables the LBA mode if the device supports this mode, and if the device was not previously formatted with LBA mode disabled. Configuration options: [Disabled] [Auto]

Block (Multi-sector Transfer) M [Auto]

Enables or disables data multi-sectors transfers. When set to **[Auto]**, the data transfer from and to the device occurs multiple sectors at a time if the device supports multi-sector transfer feature. When set to **[Disabled]**, the data transfer from and to the device occurs one sector at a time. Configuration options: [Disabled] [Auto]

PIO Mode [Auto]

Selects the PIO mode. Configuration options: [Auto] [0] [1] [2] [3] [4]

DMA Mode [Auto]

Selects the DMA mode. Configuration options: [Auto]

SMART Monitoring [Auto]

Sets the Smart Monitoring, Analysis, and Reporting Technology. Configuration options: [Auto] [Disabled] [Enabled]

32Bit Data Transfer [Enabled]

Enables or disables 32-bit data transfer. Configuration options: [Disabled] [Enabled]

2.3.4 Storage Configuration

The items in this menu allow you to set or change the configurations for the SATA devices installed in the system. Select an item then press **<Enter>** if you want to configure the item.

ATA/IDE Configuration [Enhanced]

Allows you to set the ATA/IDE configuration.

Configuration options: [Disabled] [Compatible] [Enhanced]

Enhanced Mode Support On [S-ATA]

Sets Serial ATA, Parallel ATA or both as native mode.

Configuration options: [S-ATA+P-ATA] [S-ATA] [P-ATA].

IDE Detect Time Out (Sec) [35]

Selects the time out value for detecting ATA/ATAPI devices.

Configuration options: [0] [5] [10] [15] [20] [25] [30] [35]

2.3.5 System Information

This menu gives you an overview of the general system specifications. The BIOS automatically detects the items in this menu.

BIOS Information

Displays the auto-detected BIOS information.

Processor

Displays the auto-detected CPU specification.

System Memory

Displays the auto-detected system memory.

2.4 Advanced menu

The **Advanced** menu items allow you to change the settings for the CPU and other system devices.



Take caution when changing the settings of the Advanced menu items. Incorrect field values can cause the system to malfunction.

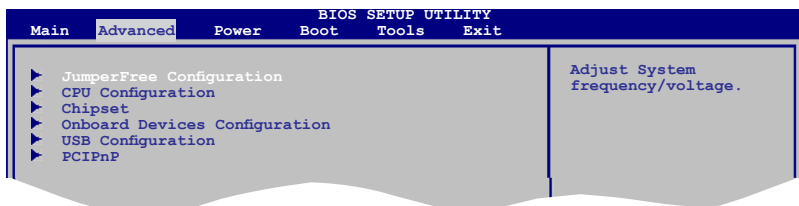

2.4.1 JumperFree Configuration

The items in this menu allows you to adjust the system frequency/voltage.

AI Overclocking [Auto]

Allows selection of CPU overclocking options to achieve desired CPU internal frequency. Select either one of the preset overclocking configuration options:

Manual - allows you to individually set overclocking parameters.

Auto - loads the optimal settings for the system.

Overclock Profile - loads overclocking profiles with optimal parameters for stability when overclocking.



The following two items appear only when you set the **AI Overclocking** item to **[MANUAL]**.

CPU Frequency [xxx]

Displays the frequency sent by the clock generator to the system bus and PCI bus. The value of this item is auto-detected by the BIOS. Use the <+> and <-> keys to adjust the CPU frequency. You can also type the desired CPU frequency using the numeric keypad. The values range from 200 to 800. Refer to the table below for the correct Front Side Bus and CPU External Frequency settings.

FSB / CPU External Frequency Synchronization

Front Side Bus	CPU External Frequency
FSB 1333	333 MHz
FSB 1066	266 MHz
FSB 800	200 MHz

PCI Express Frequency [Auto]

Allows you to select the PCI Express frequency. Configuration options: [Auto] [90] [91] [92]~[150]



The following item appears only when you set the **AI Overclocking** item to **[Overclock Profile]**.

Overclock Options [Overclock 5%]

Allows you to select the overclock options. Configuration options: [Overclock 5%] [Overclock 10%] [Overclock 15%] [Overclock 20%] [Test Mode]

DRAM Frequency [Auto]

Allows you to set the DRAM frequency. Configuration options: [Auto] [800 MHz] [1067MHz]



The following table shows the DRAM Frequency options that appear when the FSB value is 1333, 1066, and 800.

FSB	DDR3 DRAM Frequency						
	Auto	800MHz	960MHz	1000MHz	1067MHz	1100MHz	1333MHz
1333	v	v			v		v
1066	v	v			v		
800	v	v					

FSB	DDR2 DRAM Frequency						
	Auto	667MHz	800MHz	960MHz	1000MHz	1067MHz	1100MHz
1333	v	v	v		v		v
1066	v	v	v			v	
800	v	v	v				



Selecting a very high DRAM frequency may cause the system to become unstable! If this happens, revert to the default setting.

Memory Voltage [Auto]

Allows you to set the memory voltage. The values range from 1.5000V to 2.4450V with a 0.0150V increment. Key in the value directly or use +/- to adjust the voltage.

Configuration options: [Auto]

NB Voltage [Auto]

Allows you to set the Northbridge voltage. The values range from 1.12500V to 1.51875V with a 0.00625V increment. Key in the value directly or use +/- to adjust the voltage.

Configuration options: [Auto]

VTT Voltage [Auto]

Allows you to set the VTT voltage. The values range from 1.20000V to 1.29375V with a 0.00625V increment. Key in the value directly or use +/- to adjust the voltage.

Configuration options: [Auto]

SB 1.5V Voltage [Auto]

Allows you to set the SouthBridge chipset voltage. Configuration options: [1.5V] [1.6V]

Auto PSI [Enabled]

Allows you to enable or disable the Auto PSI mode.

Configuration options: [Disabled] [Enabled]

2.4.2 CPU Configuration

The items in this menu show the CPU-related information that the BIOS automatically detects.

Ratio CMOS Setting [Auto]

Sets the ration between CPU core clock and the FSB frequency. Configuration option: [Auto]



-
- If an invalid ratio is set in CMOS then actual and set values may differ.
 - Key in ratio numbers directly.
-

C1E Support [Enabled]

Allows you to enable or disable C1E Support. Configuration options: [Disabled] [Enabled]

Max CPUID Value Limit [Disabled]

Setting this item to **[Enabled]** allows legacy operating systems to boot even without support for CPUs with extended CPUID functions. Configuration options: [Disabled] [Enabled]

Intel(R) Virtualization Tech [Enabled]

Enables or disables Intel® Virtualization Technology. Virtualization enhanced by Intel® Virtualization Technology allows a platform to run multiple operating systems and applications in independent partitions. With virtualization, one computer system can function as multiple virtual systems. Configuration options: [Enabled] [Disabled]

CPU TM Function [Enabled]

Enables or disables Intel® CPU Thermal Monitor (TM) function, a CPU overheating protection function. When enabled, the CPU core frequency and voltage are reduced when the CPU overheats. Configuration options: [Disabled] [Enabled]

Execute-Disable Bit Capability [Enabled]

Allows you to enable or disable the No-Execution Page Protection Technology. Setting this item to **[Disabled]** forces the XD feature flag to always return to zero (0). Configuration options: [Disabled] [Enabled]



The following item appears only when you installed an Intel® Pentium® 4 or later CPU that supports the Enhanced Intel SpeedStep® Technology (EIST).

Intel(R) SpeedStep(TM) Tech [Enabled]

Allows you to use the Enhanced Intel® SpeedStep® Technology. When set to [Enabled], you can adjust the system power settings in the operating system to use the EIST feature. Set this item to [Disabled] if you **do not** want to use the EIST. Configuration options: [Enabled] [Disabled]

2.4.3 Chipset

The Chipset menu allows you to change the advanced chipset settings. Select an item then press <Enter> to display the sub-menu.

North Bridge Configuration

Memory Remap Feature [Enabled]

Allows you to enable or disable the remapping of overlapped PCI memory above the total physical memory. Configuration options: [Disabled] [Enabled]

Configure DRAM Timing by SPD [Enabled]

Allows you to enable or disable configuring DRAM Timing by SPD. Configuration options: [Enabled] [Disabled]

Initiate Graphic Adapter [PEG/PCI]

Allows you to select the graphics controller as the primary boot device. Configuration options: [IGD] [PCI/IGD] [PCI/PEG] [PEG/IGD] [PEG/PCI]

IGD Graphics Mode Select [Enabled, 32MB]

Allows you to select the amount of system memory used by the Internal graphics device. Configuration options: [Disabled] [Enabled, 32MB] [Enabled, 48MB] [Enabled, 64MB] [Enabled, 128MB]

GTT Graphics Memory Size [No VT mode, 2MB]

This item is not user-configurable.

DVMT Memory [256MB]

Allows you to select the DVMT memory.

Configuration options: [128MB] [256MB] [Maximum DVMT]

Protect Audio Video Path Mode [Lite]

Allows you to select the Protected Audio-Video Path (PAVP) mode.

Configuration options: [Disabled] [Lite] [Paranoid]

South Bridge Configuration

Audio Controller [Enabled]

Allows you to set the audio controller. Configuration options: [Enabled] [Disabled]

Front Panel Type [HD Audio]

Allows you to select the front panel support type. If High Definition Audio Front Panel used, set this item to [HD Audio] mode. Configuration options: [AC97] [HD Audio]

2.4.4 Onboard Devices Configuration

Onboard Gigabit LAN [Enabled]

Allows you to enable or disable the onboard Gigabit LAN controller.

Configuration options: [Enabled] [Disabled]

Onboard LAN Boot ROM [Disabled]

Allows you to enable or disable the boot ROM in the onboard LAN controller. This item appears only when the Onboard LAN item is set to Enabled.

Configuration options: [Disabled] [Enabled]

Serial Port1 Address [3F8/IRQ4]

Allows you to select the Serial Port1 base address.

Configuration options: [Disabled] [3F8/IRQ4] [2F8/IRQ3] [3E8/IRQ4] [2E8/IRQ3]

Parallel Port Address [378]

Allows you to select the Parallel Port base addresses. Configuration options: [Disabled] [378] [278] [3BC]

Parallel Port Mode [ECP]

Allows you to select the Parallel Port mode.

Configuration options: [Normal] [Bi-Directional] [EPP] [ECP]

ECP Mode DMA Channel [DMA3]

Appears only when the Parallel Port Mode is set to [ECP]. This item allows you to set the Parallel Port ECP DMA. Configuration options: [DMA0] [DMA1] [DMA3]

EPP Version [1.9]

Appears only when the Parallel Port Mode is set to [EPP].

Configuration options: [1.9] [1.7]

Parallel Port IRQ [IRQ7]

Allows you to select parallel port IRQ. Configuration options: [IRQ5] [IRQ7]

2.4.5 USB Configuration

The items in this menu allows you to change the USB-related features. Select an item then press **<Enter>** to display the configuration options.



The Module Version and USB Devices Enabled items show the auto-detected values. If no USB device is detected, the item shows **None**.

USB Functions [Enabled]

Allows you to disable or enable the USB functions.
Configuration options: [Disabled] [Enabled]

USB 2.0 Controller [Enabled]

Allows you to enable or disable USB 2.0 controller.
Configuration options: [Enabled] [Disabled]

Legacy USB Support [Auto]

Allows you to enable or disable support for Legacy USB storage devices, including USB flash drives and USB hard drives. Setting to **[Auto]** allows the system to detect the presence of USB devices at startup. If detected, the USB controller legacy mode is enabled. If no USB device is detected, the legacy USB support is disabled.
Configuration options: [Disabled] [Enabled] [Auto]

USB 2.0 Controller Mode [HiSpeed]

Allows you to configure the USB 2.0 controller in HiSpeed (480Mbps) or Full Speed (12Mbps). Configuration options: [FullSpeed] [HiSpeed]



The following items may only appear when a USB storage device is plugged.

USB Mass Storage Device Configuration

USB Mass Storage Reset Delay [20 Sec]

Allows you to set the maximum time that the BIOS waits for the USB storage device to initialize. Configuration options: [10 Sec] [20 Sec] [30 Sec] [40 Sec]

Emulation Type [Auto]

Allows you to select the emulation type. Configuration options: [Auto] [Floppy] [Forced FDD] [Hard Disk] [CDROM]

2.4.6 PCI PnP

The PCI PnP menu items allow you to change the advanced settings for PCI/PnP devices. The menu includes setting IRQ and DMA channel resources for either PCI/PnP or legacy ISA devices, and setting the memory size block for legacy ISA devices.



Take caution when changing the settings of the PCI PnP menu items. Incorrect field values can cause the system to malfunction.

Plug and Play O/S [No]

When set to [No], BIOS configures all the devices in the system. When set to [Yes] and if you install a Plug and Play operating system, the operating system configures the Plug and Play devices not required for boot. Configuration options: [No] [Yes]

2.5 Power menu

The Power menu items allow you to change the settings for the Advanced Power Management (APM). Select an item then press <Enter> to display the configuration options.

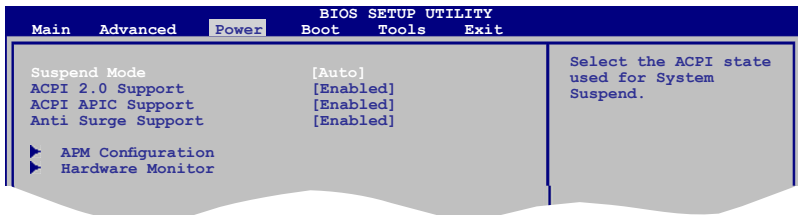

2.5.1 Suspend Mode [Auto]

Allows you to select the Advanced Configuration and Power Interface (ACPI) state to be used for system suspend. Configuration options: [S1 (POS) Only] [S3 Only] [Auto]

2.5.2 ACPI 2.0 Support [Enabled]

Allows you to add more tables for Advanced Configuration and Power Interface (ACPI) 2.0 specifications. Configuration options: [Disabled] [Enabled]

2.5.3 ACPI APIC Support [Enabled]

Allows you to enable or disable the Advanced Configuration and Power Interface (ACPI) support in the Application-Specific Integrated Circuit (ASIC). When set to Enabled, the ACPI APIC table pointer is included in the RSDT pointer list. Configuration options: [Disabled] [Enabled]

2.5.4 Anti Surge Support [Enabled]

Allows you to enable or disable the Anti-Surge protection. Configuration options: [Disabled] [Enabled]

2.5.5 APM Configuration

Restore on AC Power Loss [Power Off]

When set to [Power Off], the system goes into off state after an AC power loss. When set to [Power On], the system goes on after an AC power loss. When set to [Last State], the system goes into either off or on state, whatever the system state was before the AC power loss. Configuration options: [Power Off] [Power On] [Last State]

Power On By RTC Alarm [Disabled]

Allows you to enable or disable RTC to generate a wake event. When this item is set to Enabled, the items RTC Alarm Date, RTC Alarm Hour, RTC Alarm Minute, and RTC Alarm Second appear with set values. Configuration options: [Disabled] [Enabled]

Power On By External Modem [Disabled]

This allows either settings of [Enabled] or [Disabled] for powering up the computer when the external modem receives a call while the computer is in Soft-off mode. Configuration options: [Disabled] [Enabled]

Power On By PCI (E) Device [Disabled]

When set to [Enabled], this parameter allows you to wake the system through a PCI Express/PCI card. This feature requires an ATX power supply that provides at least 1A on the +5VSB lead. Configuration options: [Disabled] [Enabled]

Power On By PS/2 Keyboard [Disabled]

Allows you to use specific keys on the keyboard to turn on the system. This feature requires an ATX power supply that provides at least 1A on the +5VSB lead. Configuration options: [Disabled] [Space Bar] [Ctrl-Esc] [Power Key]

Power On By PS/2 Mouse [Disabled]

When set to [Enabled], this parameter allows you to use the PS/2 mouse to turn on the system. This feature requires an ATX power supply that provides at least 1A on the +5VSB lead. Configuration options: [Disabled] [Enabled]

2.5.6 Hardware Monitor

CPU Temperature [xxx°C/xxx°F] or [Ignored]

MB Temperature [xxx°C/xxx°F] or [Ignored]

The onboard hardware monitor automatically detects and displays the motherboard and CPU temperatures. Select **Ignored** if you do not wish to display the detected temperatures.

CPU Fan Speed [xxxxRPM] or [Ignored]

The onboard hardware monitor automatically detects and displays the CPU fan speed in rotations per minute (RPM). If the fan is not connected to the motherboard, the field shows **N/A**. Select Ignored if you do not wish to display the detected speed.

CPU Q-Fan Control [Enabled]

Allows you to enable or disable the CPU Q-Fan function. Configuration options: [Disabled] [Enabled]

CPU Fan Profile [Optimal Mode]

This item appears only when you enable the CPU Q-Fan Control feature and allows you to set the appropriate performance level of the CPU fan. Configuration options: [Optimal Mode] [Silent Mode] [Performance Mode]

Chassis Fan Speed [xxxxRPM] or [Ignored]

The onboard hardware monitor automatically detects and displays the chassis fan speed in rotations per minute (RPM). If the fan is not connected to the motherboard, the field shows **N/A**. Select Ignored if you do not wish to display the detected speed.

VCORE Voltage, 3.3V Voltage, 5V Voltage, 12V Voltage [xxxV] or [Ignored]

The onboard hardware monitor automatically detects the voltage output through the onboard voltage regulators.

2.6 Boot menu

The **Boot** menu items allow you to change the system boot options. Select an item then press **<Enter>** to display the sub-menu.

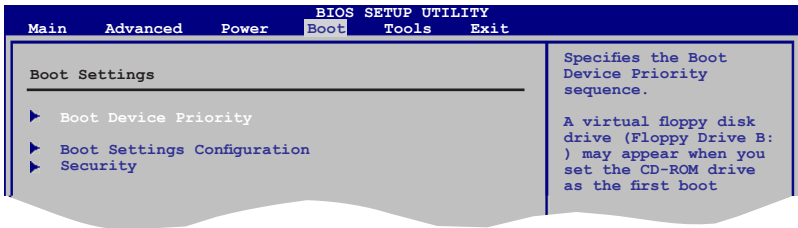

2.6.1 Boot Device Priority

1st ~ xxth Boot Device

These items specify the boot device priority sequence from the available devices. The number of device items that appears on the screen depends on the number of devices installed in the system. Configuration options: [Removable Dev.] [Hard Drive] [ATAPI CD-ROM] [Disabled]



- To select the boot device during system startup, press **<F8>** when ASUS Logo appears.
- To access Windows® OS in Safe Mode, do any of the following:
 - Press **<F5>** when ASUS Logo appears.
 - Press **<F8>** after POST.

2.6.2 Boot Settings Configuration

Quick Boot [Enabled]

Enabling this item allows the BIOS to skip some power on self tests (POST) while booting to decrease the time needed to boot the system. When set to **[Disabled]**, BIOS performs all the POST items. Configuration options: [Disabled] [Enabled]

Full Screen Logo [Enabled]

This allows you to enable or disable the full screen logo display feature. Configuration options: [Disabled] [Enabled]



Set this item to **[Enabled]** to use the ASUS MyLogo2™ feature.

AddOn ROM Display Mode [Force BIOS]

Sets the display mode for option ROM. Configuration options: [Force BIOS] [Keep Current]

Bootup Num-Lock [On]

Allows you to select the power-on state for the NumLock. Configuration options: [Off] [On]

Wait For 'F1' If Error [Enabled]

When set to **Enabled**, the system waits for the F1 key to be pressed when error occurs. Configuration options: [Disabled] [Enabled]

Hit 'DEL' Message Display [Enabled]

When set to **[Enabled]**, the system displays the message **Press DEL to run Setup** during POST. Configuration options: [Disabled] [Enabled]

2.6.3 Security

The **Security** menu items allow you to change the system security settings. Select an item then press **<Enter>** to display the configuration options.

Change Supervisor Password

Select this item to set or change the supervisor password. The **Supervisor Password** item on top of the screen shows the default **Not Installed**. After you set a password, this item shows **Installed**.

To set a Supervisor Password:

1. Select the **Change Supervisor Password** item and press **<Enter>**.
2. In the password box, key in a password containing up to six letters or numbers, or both, then press **<Enter>**.
3. Confirm the password when prompted.

The message **Password Installed** appears after you successfully set your password.

To change the supervisor password, follow the same steps in setting a supervisor password.

To clear the supervisor password, select the **Change Supervisor Password** then press **<Enter>** twice. The message **Password uninstalled** appears.



If you forget your BIOS password, you can clear it by erasing the CMOS Real Time Clock (RTC) RAM. See section 1.9 **Jumpers** for information on how to erase the RTC RAM.

After you have set a supervisor password, the other items appear to allow you to change other security settings.

User Access Level [Full Access]

This item allows you to select the access restriction to the Setup items.

Configuration options: [No Access] [View Only] [Limited] [Full Access]

[No Access] - prevents user access to the Setup utility.

[View Only] - allows access but does not allow change to any field.

[Limited] - allows changes only to selected fields, such as Date and Time.

[Full Access] - allows viewing and changing all the fields in the Setup utility.

Change User Password

Select this item to set or change the user password. The **User Password** item on top of the screen shows the default **Not Installed**. After you set a password, this item shows **Installed**.

To set a User Password:

1. Select the **Change User Password** item and press **<Enter>**.
2. In the password box, key in a password containing up to six letters or numbers, or both, then press **<Enter>**.
3. Confirm the password when prompted.

The message **Password Installed** appears after you set your password successfully.

To change the user password, follow the same steps in setting a user password.

Clear User Password

Select this item to clear the user password.

Password Check [Setup]

When set to **[Setup]**, BIOS checks for user password when accessing the Setup utility. When set to **[Always]**, BIOS checks for user password both when accessing Setup and booting the system. Configuration options: [Setup] [Always]

2.7 Tools menu

The Tools menu items allow you to configure options for special functions. Select an item then press **<Enter>** to display the sub-menu.

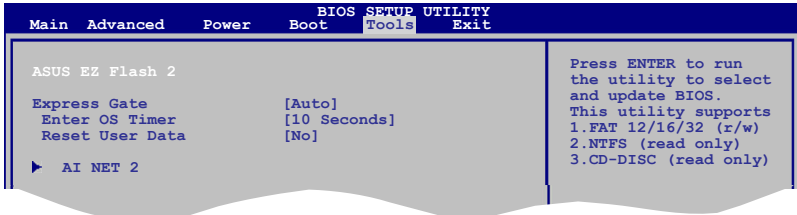

2.7.1 ASUS EZ Flash 2

Allows you to run ASUS EZ Flash 2. When you press **<Enter>**, a confirmation message appears. Use the left/right arrow key to select between **[Yes]** or **[No]**, then press **<Enter>** to confirm your choice. See section 2.1.2 **ASUS EZ Flash 2** for details.

2.7.2 Express Gate [Auto]

Allows you to enable or disable the ASUS Express Gate feature. The ASUS Express Gate feature is a unique instant-on environment that provides quick access to the Internet browser and Skype. Configuration options: **[Enabled]** **[Disabled]** **[Auto]**

Enter OS Timer [10 Seconds]

Sets countdown duration that the system waits at the Express Gate's first screen before starting Windows or other installed OS. Choose **[Prompt User]** to stay at the first screen of Express Gate for user action. Configuration options: **[Prompt User]** **[1 second]** **[3 seconds]** **[5 seconds]** **[10 seconds]** **[15 seconds]** **[20 seconds]** **[30 seconds]**

Reset User Data [No]

Allows you to clear Express Gate's user data. Configuration options: **[No]** **[Reset]**

When setting this item to **[Reset]**, ensure to save the setting to the BIOS so that the user data will be cleared the next time you enter the Express Gate. User data includes the Express Gate's settings as well as any personal information stored by the web browser (bookmarks, cookies, browsing history, etc.). This is useful in the rare case where corrupt settings prevent the Express Gate environment from launching properly.



The first time wizard will run again when you enter the Express Gate environment after clearing its settings.

2.7.3 AI NET 2

Check Realtek LAN cable [Disabled]

Enables or disables checking of the Realtek LAN cable during the Power-On Self-Test (POST). Configuration options: **[Disabled]** **[Enabled]**

2.8 Exit menu

The Exit menu items allow you to load the optimal or failsafe default values for the BIOS items, and save or discard your changes to the BIOS items.

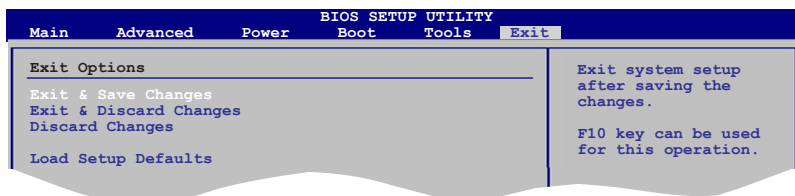

Pressing **<Esc>** does not immediately exit this menu. Select one of the options from this menu or **<F10>** from the legend bar to exit.

Exit & Save Changes

Once you are finished making your selections, choose this option from the Exit menu to ensure the values you selected are saved to the CMOS RAM. An onboard backup battery sustains the CMOS RAM so it stays on even when the PC is turned off. When you select this option, a confirmation window appears. Select **OK** to save changes and exit.

Exit & Discard Changes

Select this option only if you do not want to save the changes that you made to the Setup program. If you made changes to fields other than System Date, System Time, and Password, the BIOS asks for a confirmation before exiting.

Discard Changes

This option allows you to discard the selections you made and restore the previously saved values. After selecting this option, a confirmation appears. Select **OK** to discard any changes and load the previously saved values.

Load Setup Defaults

This option allows you to load the default values for each of the parameters on the Setup menus. When you select this option or if you press **<F5>**, a confirmation window appears. Select **OK** to load default values. Select **Exit & Save Changes** or make other changes before saving the values to the non-volatile RAM.

